



**CATALOGUE**  
**IN-LINE FANS**





**VORTICE S.p.A.** is part of a multinational group, **VORTICE GROUP**, which operates through its own companies or local distributors in over 90 countries worldwide and has a rich product portfolio that guarantees air quality and climate comfort. The headquarters of VORTICE S.p.A are in Tribiano (Milan).



VORTICE GROUP also includes:

[1]  
**VORTICE LIMITED**, the UK subsidiary of VORTICE S.p.A., established in 1977 and based in Burton on Trent.

[2]  
**VORTICE INDUSTRIAL**, born from the acquisition in 2010 of Loran srl, based in Isola della Scala (VR).

[3]  
**VORTICE VENTILATION SYSTEM**, a company inaugurated in 2013 with headquarters in Changzhou, China.

[4]  
**VORTICE LATAM S.A.**, based in Alajuela in Costa Rica, established in 2012.

[5]  
**CASALS VENTILACIÓN AIR INDUSTRIAL S.L.**, historic Spanish brand, based in Sant Joan de les Abadesses, Girona, acquired in 2019.



# INDEX

<b>NEW</b> LINEO RANGE ..... pag. 04 In-line mixed flow fans	CA WE D E RANGE ..... pag. 54 Painted sheet steel mixed flow duct fans for external wall
<b>NEW</b> LINEO QUIET RANGE ..... pag. 06 In-line mixed flow fans	CA M D E W RANGE ..... pag. 58 Steel sheet mixed flow wall fans
<b>NEW</b> LINEO RANGE ..... pag. 20 "Energy Saving" In-line mixed flow fans	CA M D E R F RANGE ..... pag. 64 Painted steel sheet mixed flow roof fans
CA V O RANGE ..... pag. 34 In-line centrifugal fans in self-extinguishing plastic	CA-IN-LINE RANGE ..... pag. 70 Compact flat in-line centrifugal fans
CA M D RANGE ..... pag. 40 In-line centrifugal fans in metal	CA-IN-LINE QUIET RANGE ..... pag. 78 Soundproof compact flat in-line centrifugal fans
CA E S RANGE ..... pag. 48 "Energy Saving" in-line centrifugal fans in metal	CA-IN-LINE QUIET E S RANGE ..... pag. 84 Soundproof compact flat in-line centrifugal EC fans

## CE MARKING

Commercial Ventilation appliances conform to the following European Directives:

2009/125/EC Directive Ecocompatible Design (ErP),  
2006/42/EC Machines Directive (MD),  
2004/108/EC Electromagnetic Compatibility Directive (EMC),

According to the following state-of-the-art Standards:

### Safety

EN 60204-1; EN ISO 12100-1; EN ISO 12100-2; EN ISO 12499;  
EN ISO 13857; EN 60335-1; EN 60335-2-80; EN 62233

### Electromagnetic Compatibility

EN 55014-1; EN 55014-2; EN 61000-3-2; EN 61000-3-3

The fans built into the IN LINE Range are conform to the following European Directive N° 1253/2014 and N° 1254/2014.

# LINEO RANGE

## In-line mixed flow fans

The **LINEO** range products are “mixed flow” fans specifically designed for horizontal or vertical ducted installation.

**VENTILATION OF RESIDENTIAL,  
COMMERCIAL OR INDUSTRIAL PREMISES.**



They all have high levels of energy efficiency and meet the requirements of ERP Regulation 327/2011/EU. The fans in the renewed LINEO range boast

**HIGH PERFORMANCE, LOW ENERGY CONSUMPTION, LOW NOISE EMISSIONS AND EASE OF INSTALLATION AND MAINTENANCE.**



The LINEO range products are characterised by technopolymer enclosures for increased fire resistance safety class E2, according to EN ISO 11925-2:2010 and have a high degree of protection against water. The classification only applies to a properly installed product.

## THE DESIGN

### CONSTRUCTION FEATURES COMMON TO THE RANGE

The design consists of the following:

- a central motor mount which encloses the fan motor unit and houses the wiring devices externally, in an easily reachable position;

the main body, fixed to a pair of end supports arranged for connection to the suction and delivery pipes, which is designed to rotate on its own axis to facilitate the housing of the product in small spaces and its wiring through the contacts positioned on its external surface;

The ease with which it can be removed without altering the surrounding piping system, greatly speeds up and facilitates maintenance;

- the air flow rectifiers on the delivery side work, in synergy with the upstream impeller, optimise the managed air flow, maximising performance and increasing efficiency, reducing the occurrence of vortices and minimising noise emissions;
- the mixed flow type impellers combine the advantages of helical fans (high flow rates and flow around the axis of the impeller), with the high pressures of centrifugal fans; the directly coupled motors have shafts mounted on ball bearings, ensuring a virtually “maintenance free” operation;
- the timer in the T models allows the operation of the appliance to be programmed at maximum speed and ease at a range between 3’ and 20’, which can be set during installation.

### KEY FEATURES

- high-performance, top-of-the-range;
- easy maintenance. Each component allows easy connection and disconnection with the nearby elements, and easy access to the inner components (motor-impeller) and their replacement. In the case of the silenced products, the sound absorbing shells refitted at the end of the maintenance process restore the original sound performance under test conditions;
- the motors have a minimum guaranteed life in continuous operation at maximum speed and at maximum ambient temperature of 30,000 or 40,000 hours depending on the type;
- completeness of the range, designed to offer the ideal product to meet the specific requirements of the system in terms of performance, consumption, quiet operation, operating costs and purchase price.

LINEO QUIET RANGE  
IN-LINE MIXED FLOW FANS

NEW

# LINEO QUIET RANGE

The **LINEO QUIET** range products are characterised by the use of a **sound-absorbing coating** which is fully integrated in the outer casing and optimised to minimise environmental sound emissions.

HIGH-LEVEL PERFORMANCE,  
AT THE TOP OF THE RANGE.





because energy  
has to be....

# SAVED

The profiles of the impeller,  
of the flow rectifiers and ogival profile  
of the flow driver work in synergy with  
the upstream impeller to optimise the  
managed air flow, maximising performance  
and increasing efficiency, reducing  
the occurrence of vortices and  
minimising noise  
emissions.

because silence has to be...

# BUILT

## IMPELLER

Designed to reach the ERP efficiency levels

## CO-MOULDED SHELL

Easily removable during maintenance without any effect on its sound dampening effect

## INLET NOZZLE

Dimensioned to sustain the product in the wall and ceiling installation

## DIVERGENT ELEMENT

It helps the impeller to increase the performance

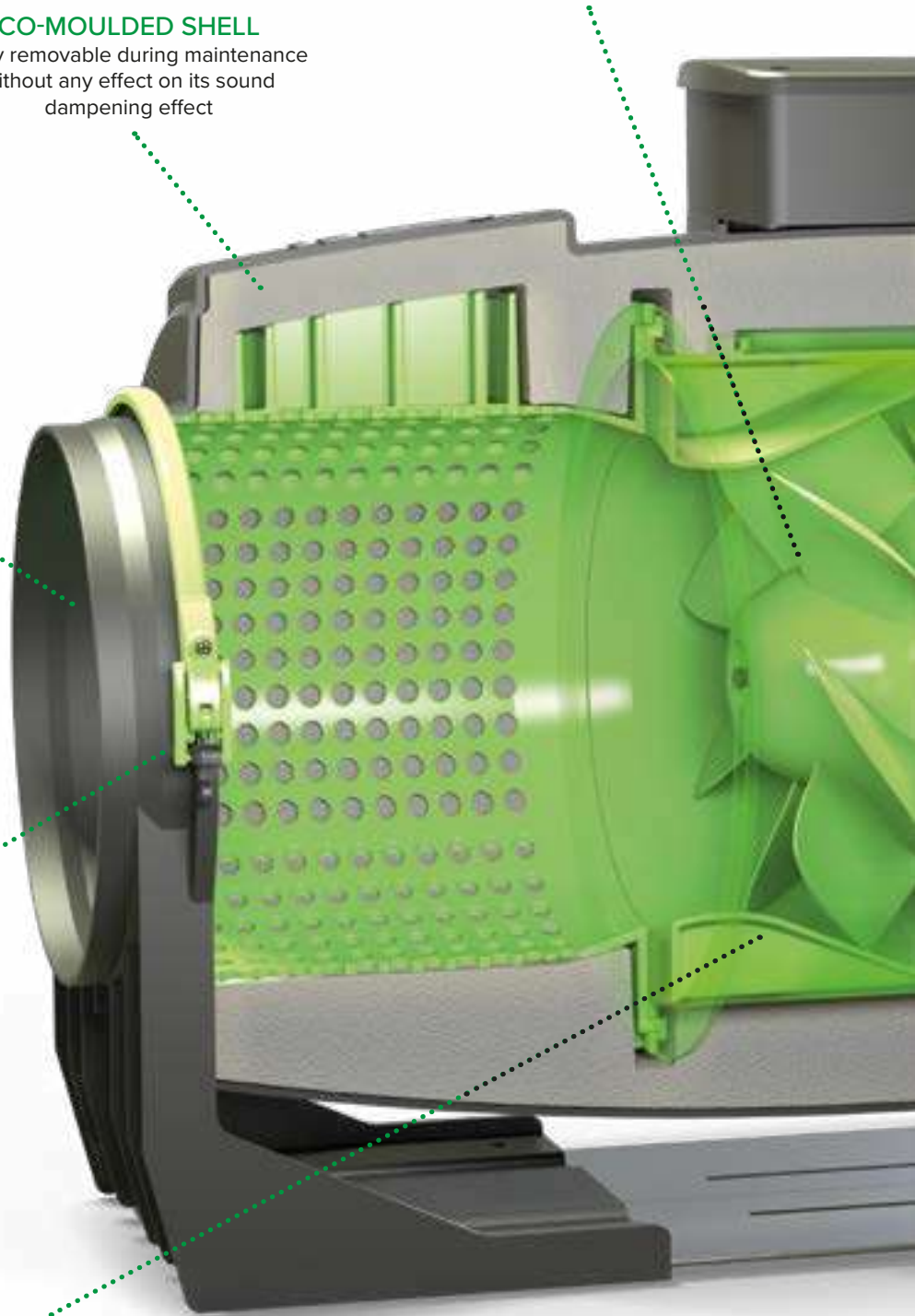





### ELECTRIC BOX

Produced in a material granting electrical and fire resistance

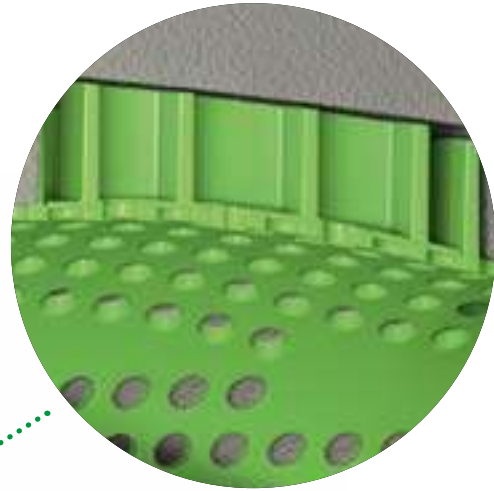

### HELMHOLTZ RESONATOR GROUP

Passive sound dampener used to decrease the noise levels at predetermined frequencies

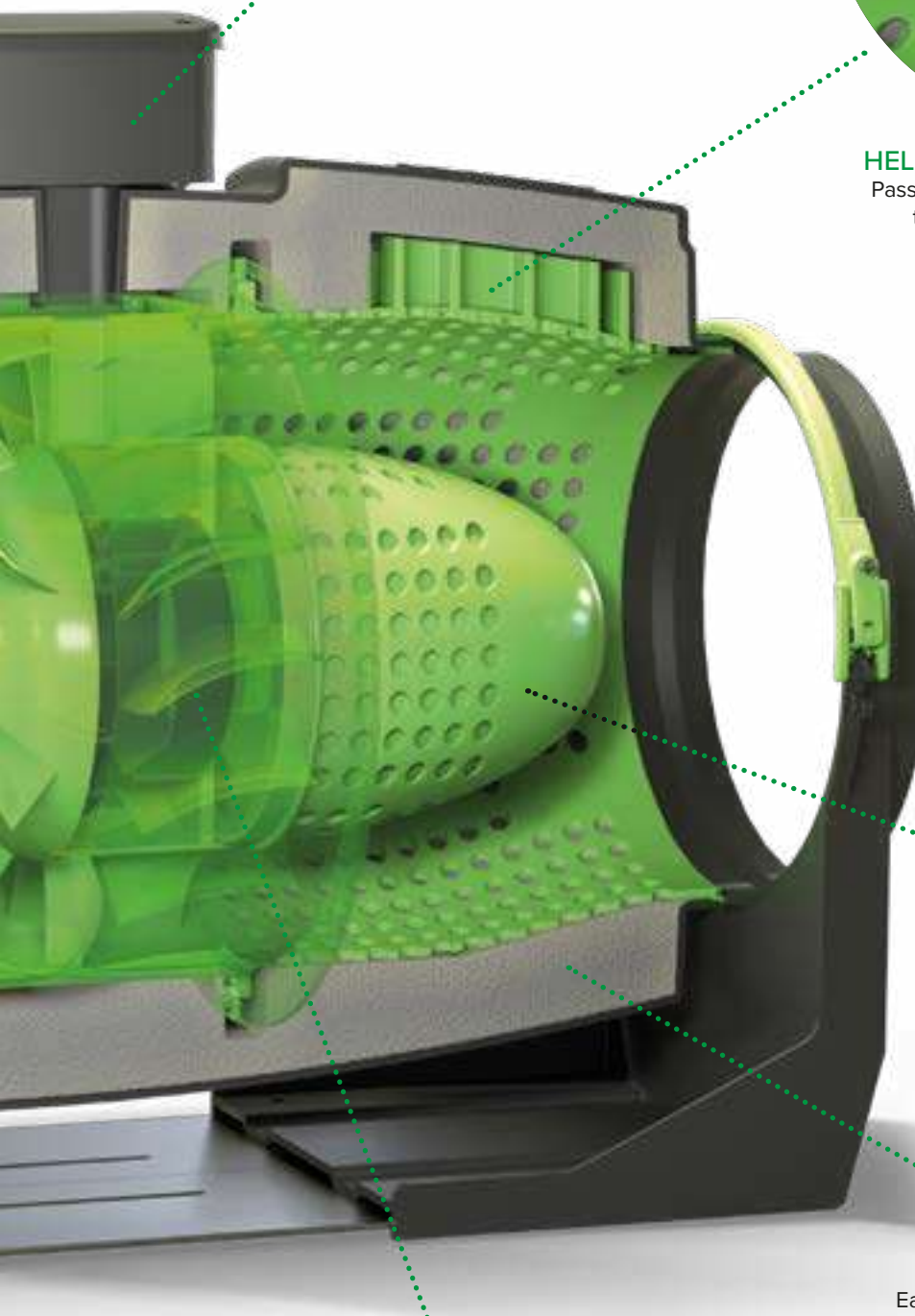

### FLOW DRIVER

It corrects the airflow after the impeller and the rectifier, avoiding energy losses due to vortices

### RECTIFIER BLADES

Designed with the impeller to rectify the airflow and avoid flow problems on the downstream part of the product

### CO-MOULDED SHELL

Easily removable during maintenance without any effect on his sound dampening effect



**LINEO QUIET RANGE**  
IN-LINE MIXED FLOW FANS

NEW

## LINEO QUIET ES RANGE

equipped with EC brushless motors

The products in the **LINEO QUIET ES** range differ from the corresponding versions of the LINEO QUIET range due to the use of electronically controlled 2 speed EC brushless (low consumption) motors. Each speed can be set at installation. Alternatively the units can run at 1 speed only, adjustable by user through 0-10V signal.



## LINEO QUIET RANGE

equipped with AC motors

The **LINEO QUIET** range products are fitted with traditional AC motors, 2 or 3 speed depending on the model.





Commercial Ventilation

because environment  
has to be....

# SUSTAINED



**LINEO QUIET ES RANGE**  
IN-LINE MIXED FLOW FANS

**NEW**

**TECHNICAL AND PERFORMANCE DATA - LINEO QUIET ES\***

Models	Code	V~50/60HZ	W		A		RPM		Max Airflow		Max Pressure		Protection grade**	Max °C	KG
			4/6/8/10V		4/6/8/10V		4/6/8/10V		m³/h		Pa				
			4/6/8/10V	4/6/8/10V	4/6/8/10V	4/6/8/10V	4/6/8/10V	4/6/8/10V	4/6/8/10V	4/6/8/10V					
LINEO 100 QUIET ES	17170	220-240	6.2	0.09	1140	135	37.5	3.5	34.3	IP45	60	3,8			
			8.3	0.12	1450	175	48.6	5.8	56.9						
			14.7	0.18	2050	250	69.4	11.4	111.8						
			23	0.26	2510	300	83.3	24.8	243.2						
LINEO 125 QUIET ES	17171	220-240	6.6	0.10	1080	180	50	3.3	32.4	IP45	60	3,6			
			8.8	0.12	1340	225	62.5	5.6	54.9						
			16	0.18	1865	320	88.9	11	107.9						
			24	0.26	2210	380	105.6	23.7	232.4						
LINEO 150 QUIET ES	17172	220-240	7.7	0.11	1015	250	69.4	4.6	45.1	IP45	60	5,4			
			10.6	0.14	1240	305	84.7	7.5	73.6						
			20	0.24	1700	430	119.4	14.7	107.9						
			31	0.34	2030	515	143.1	24.2	237.3						
LINEO 160 QUIET ES	17173	220-240	7.7	0.11	1010	250	69.4	4.5	44.1	IP45	60	5,2			
			10.6	0.14	1245	315	87.5	7.5	73.6						
			19.7	0.23	1685	435	120.8	14.4	141.2						
			31	0.34	2035	525	145.8	23.9	234.4						
LINEO 200 QUIET ES	17174	220-240	15.2	0.18	1380	570	158.3	8.6	84.3	IP45	50	8,6			
			25.3	0.27	1705	720	200	13.9	136.3						
			52.4	0.52	2245	945	262.5	22.9	224.6						
			88	0.78	2700	1145	318.1	33.6	329.5						
LINEO 250 QUIET ES	17175	220-240	20	0.19	1365	750	208.3	10.1	99.1	IP45	50	13,4			
			35	0.28	1680	940	261.1	15.6	153						
			75	0.60	2250	1250	347.2	26.6	260.9						
			125	0.97	2680	1485	412.4	37.5	367.8						
LINEO 315 QUIET ES	17176	220-240	42	0.31	1260	1400	388.9	12.9	126.5	IP45	50	28,3			
			72	0.51	1560	1730	480.6	19.5	191.2						
			155	1.10	2070	2300	638.9	33.8	331.5						
			220	1.52	2350	2630	730.6	38.7	379.5						

\* all data referred to supply at 50 Hz

\*\* protection grade referred to ducted units

**SOUND LEVELS - LINEO QUIET ES**

SOUND POWER Lw dB (A)													
Models	Code	INTAKE				SUPPLY				BREAKOUT			
		4V	6V	8V	10V	4V	6V	8V	10V	4V	6V	8V	10V
LINEO 100 QUIET ES	17170	64.8	72.4	77.5	79.1	64.5	73.2	75.6	79	38.1	46.2	46.5	47.9
LINEO 125 QUIET ES	17171	63.7	71	75.8	78.3	64.3	73.5	74.7	79.4	42.3	48.5	51	51.7
LINEO 150 QUIET ES	17172	65.5	72.1	75	76.9	66	72.8	75.6	76.7	40.7	45.8	49.6	50.8
LINEO 160 QUIET ES	17173	65.5	72.1	75	76.9	66	72.8	75.6	76.7	40.7	45.8	49.6	50.8
LINEO 200 QUIET ES	17174	74.8	80	82.6	84.7	72.4	77.6	80.5	83.6	49.9	54.4	56.9	59.1
LINEO 250 QUIET ES	17175	71.4	76.7	83.7	88.1	70.7	76.1	83	87.2	44.4	49.1	55.9	60
LINEO 315 QUIET ES	17176	82.6	85.7	88.3	89.1	73.3	80.6	82.2	84.5	55.9	62.3	64.7	65.3

SOUND PRESSURE Lp dB(A)*													
Models	Code	INTAKE				SUPPLY				BREAKOUT			
		4V	6V	8V	10V	4V	6V	8V	10V	4V	6V	8V	10V
LINEO 100 QUIET ES	17170	47.3	54.9	59.9	61.5	47	55.7	25.9	47	17.6	25.6	25.9	27.4
LINEO 125 QUIET ES	17171	46.1	53.4	58.3	60.8	46.8	56	57.2	61.9	21.8	28	30.4	31.3
LINEO 150 QUIET ES	17172	48	54.6	57.4	59.4	49	55.3	58.1	59.1	20.2	25.3	29.1	30.2
LINEO 160 QUIET ES	17173	48	54.6	57.4	59.4	49	55.3	58.1	59.1	20.2	25.3	29.1	30.2
LINEO 200 QUIET ES	17174	57.3	62.4	65.1	67.1	54.8	60.1	63	66.1	29.4	33.9	36.4	38.6
LINEO 250 QUIET ES	17175	53.9	59.2	66.1	70.5	52	58.6	65.5	69.7	23.8	28.6	35.4	39.5
LINEO 315 QUIET ES	17176	65.1	68.2	70.8	71.6	55.8	63.1	64.6	67	35.4	41.8	44.1	44.8

\* Calculated in free field conditions at 3 m distance





### DIMENSIONS - LINEO QUIET ES

Models	Code	A	B	C	Ø D	E	F	G	H	L	Ø M	N	VERSION
LINEO 100 QUIET ES	17170	210	294.6	639	97	130	235	135	120	67.5	5.5	320	A
LINEO 125 QUIET ES	17171	210	294.6	504.5	122	130	235	135	120	67.5	5.5	320	A
LINEO 150 QUIET ES	17172	232	320.6	685	147	145	261.5	170	132	85	5.5	360	A
LINEO 160 QUIET ES	17173	232	320.6	570	156.5	145	261.5	170	135	85	5.5	360	A
LINEO 200 QUIET ES	17174	322.5	417.6	625.5	194.5	195	363.5	190	120	155	5.5	510	B
LINEO 250 QUIET ES	17175	318	411.9	751.5	243	189.5	363.5	200	70	170	6.5	604.5	B
LINEO 315 QUIET ES	17176	415.5	557.8	940	307	234	441	309	110	255	8.5	780	C

### VERSION A

LINEO 100 QUIET ES - LINEO 125 QUIET ES - LINEO 150 QUIET ES - LINEO 160 QUIET ES

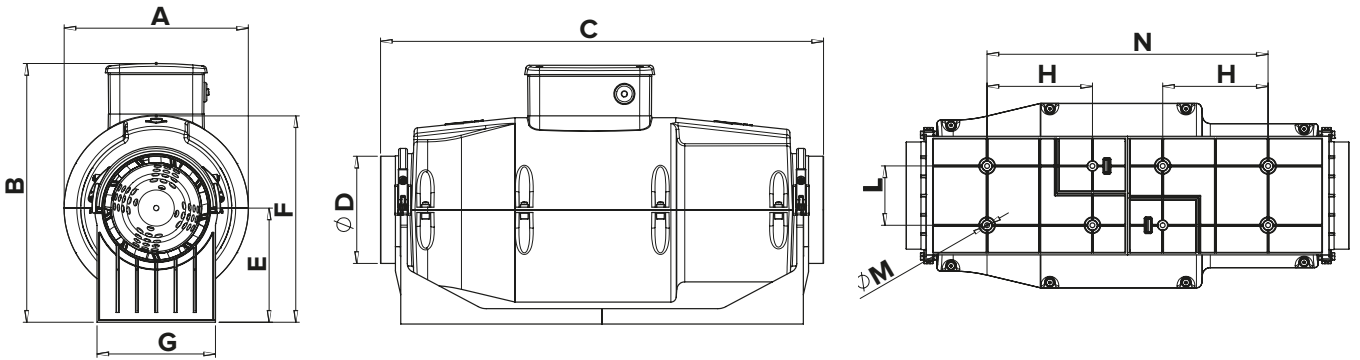

### VERSION B

LINEO 200 QUIET ES - LINEO 250 QUIET ES

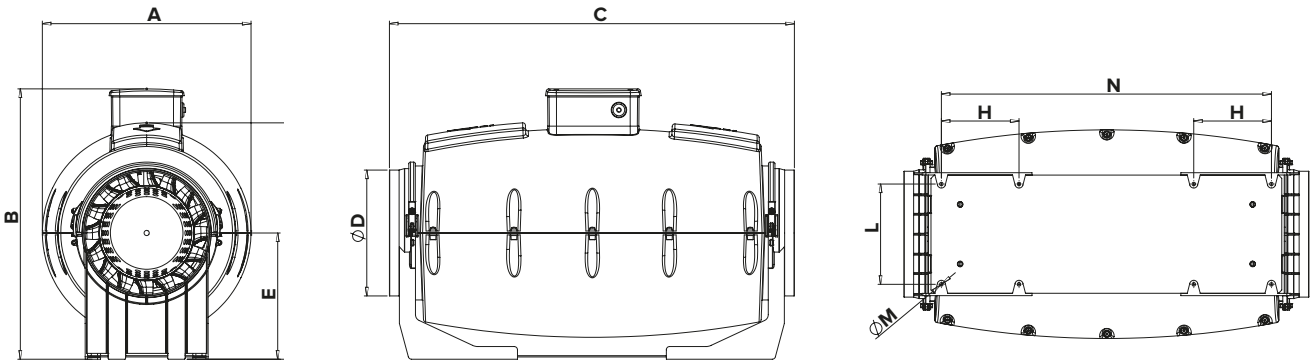

### VERSION C

LINEO 315 QUIET ES

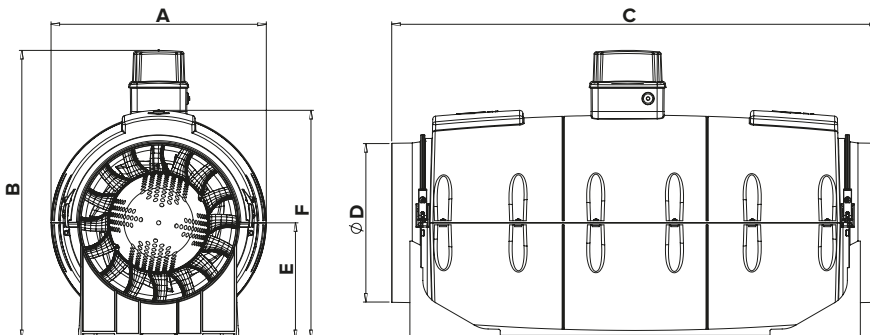

# LINEO QUIET ES RANGE

## IN-LINE MIXED FLOW FANS

NEW

### PERFORMANCE AND ABSORPTION CURVES - LINEO QUIET ES

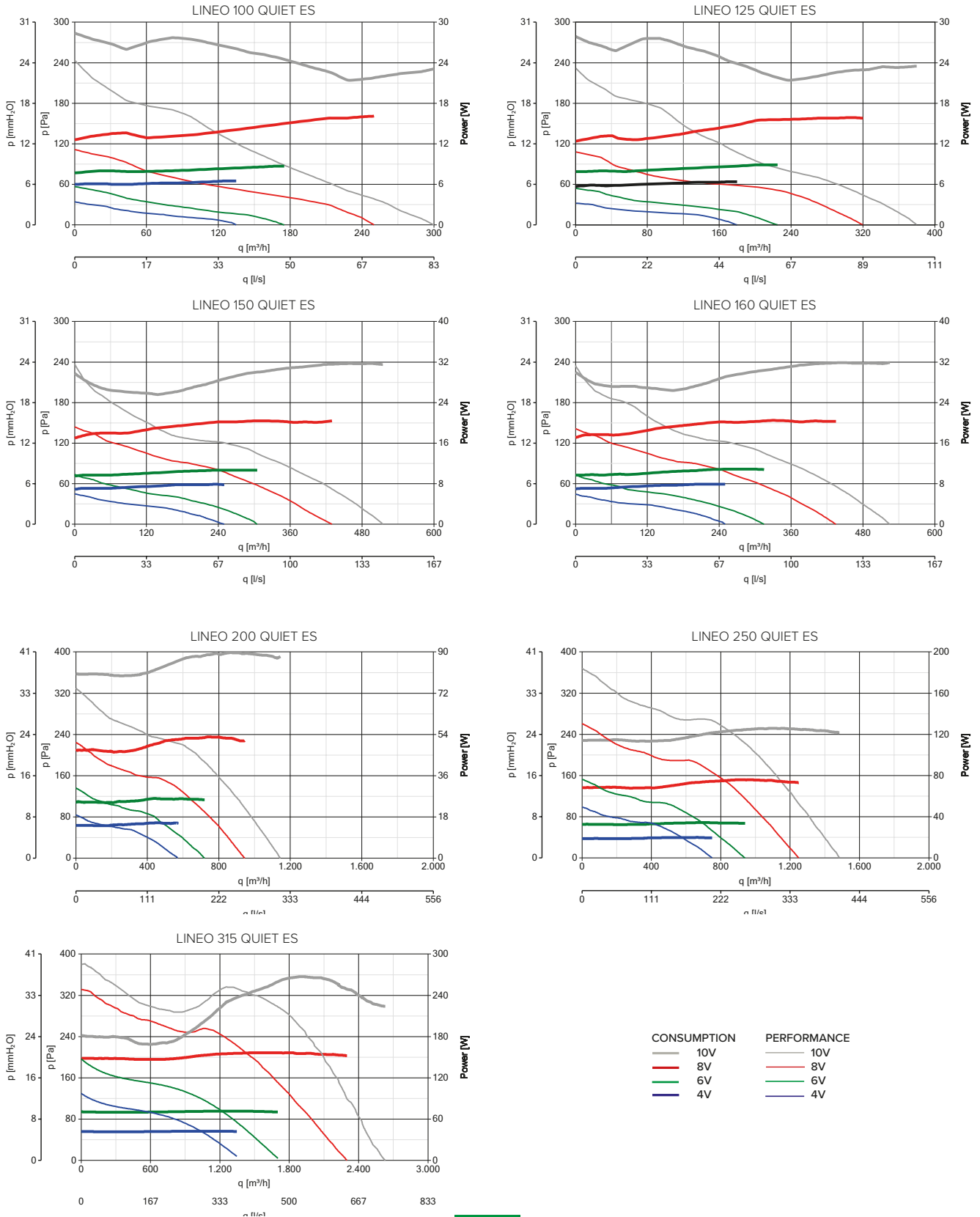









CONSUMPTION      PERFORMANCE

10V                  10V  
 8V                    8V  
 6V                    6V  
 4V                    4V





## CONTROLLERS - LINEO QUIET ES

MODELS	DESCRIPTION	CODE	PRODUCT
	<b>POT-IT</b> - POTENTIOMETER COMPATIBLE WITH FLUSH MOUNTING IN UNI 503 ELECTRIC BOX	12826	17170 - 17171 - 17172 - 17173 - 17174 17175 - 17176
	<b>POT</b> - POTENTIOMETER COMPATIBLE WITH FLUSH MOUNTING IN DIN ELECTRIC BOX	12828	17170 - 17171 - 17172 - 17173 - 17174 17175 - 17176
	<b>DUO</b> - 2 SPEED SELECTOR	22914	ALL PRODUCTS
	<b>C TEMP</b> - TEMPERATURE SENSOR	12992	ALL PRODUCTS
	<b>C SMOKE</b> - AIR QUALITY SENSOR	12993	ALL PRODUCTS
	<b>C HCS</b> - HUMIDITY SENSOR	12994	ALL PRODUCTS
	<b>C PIR</b> - PASSIVE INFRARED SENSOR	12998	ALL PRODUCTS
	<b>C TIMER</b> - TIMER	12999	ALL PRODUCTS

**LINEO QUIET RANGE**  
IN-LINE MIXED FLOW FANS

**NEW**

**TECHNICAL AND PERFORMANCE DATA - LINEO QUIET\***

Models	Code	V~50/60 HZ	W min/med/ max	A min/med/ max	RPM min/med/ max	Max Airflow		Max Pressure		grade**	Max °C	KG
						m³/h	l/s	mmH <sub>2</sub> O	Pa			
						min/med/max	min/med/max	min/med/max	min/med/max			
LINEO 100 QUIET	17160	220-240	11	0.09	1455	150	41.7	9	88.3	IP45	45	3,8
LINEO 100 T QUIET	17190		24	0.11	1880	200	55.6	11.5	112.8			
LINEO 125 QUIET	17161	220-240	11	0.09	1125	190	52.8	8	78.5	IP45	45	3,6
LINEO 125 T QUIET	17191		24	0.11	1475	250	69.4	10	98.1			
LINEO 150 QUIET	17162	220-240	24	0.14	1040	255	70.8	10.5	103	IP45	55	5,4
LINEO 150 T QUIET	17192		37	0.17	1430	350	97.2	15.5	152			
LINEO 160 QUIET	17163	220-240	24	0.14	1040	255	70.8	10.5	103	IP45	55	5,2
LINEO 160 T QUIET	17193		37	0.17	1430	350	97.2	15.5	152			
LINEO 200 QUIET	17164	220-240	50	0.34	1880	805	223.6	20.6	202	IPX5	50	8,6
LINEO 200 T QUIET	17194		80	0.42	2380	1045	290.3	26.3	257.9			
LINEO 250 QUIET	17165	220-240	95	0.42	1640	960	266.7	20.2	198.1	IPX5	50	13,4
			125	0.55	2320	1340	372.2	30.3	297.2			
LINEO 315 QUIET	17166	220-240	150	0.65	2750	1550	430.6	34.6	339.3	IPX5	50	28,3
			215	0.95	1930	2070	575	30.6	300.1			
LINEO 315 QUIET	17166	220-240	270	1.15	2360	2530	702.8	43.3	424.6	IPX5	50	28,3
			360	1.55	2705	2890	802.8	53.6	525.7			

\* all data referred to supply at 50 Hz

\*\* protection grade referred to ducted units

**SOUND LEVELS - LINEO QUIET**

Models	Code	SOUND POWER Lw dB (A)								
		INTAKE			SUPPLY			BREAKOUT		
		min	med.	max	min	med.	max	min	med.	max
LINEO 100 QUIET	17160									
LINEO 100 T QUIET	17190	62.2	70.5	74.6	62.3	68.7	74.4	36.2	41.8	46.6
LINEO 125 QUIET	17161									
LINEO 125 T QUIET	17191	60.1	64.2	70.4	60.5	64.2	70.9	36.2	41.8	45.5
LINEO 150 QUIET	17162									
LINEO 150 T QUIET	17192	60.3	68.2	77.3	62.1	67.7	76	38.2	43.4	51.2
LINEO 160 QUIET	17163									
LINEO 160 T QUIET	17193	60.3	68.2	77.3	62.1	67.7	76	38.2	43.4	51.2
LINEO 200 QUIET	17164									
LINEO 200 T QUIET	17194	76.9	83.3	86.4	75.1	81.5	85	51.6	57.4	60.7
LINEO 250 QUIET	17165	76.3	83.6	85.1	75	83.4	87.4	49.5	57	60.7
LINEO 315 QUIET	17166	82.8	87	91.7	82.8	87	89.8	58.8	62.9	65.9

Models	Code	SOUND PRESSURE LP dB(A)*								
		INTAKE			SUPPLY			BREAKOUT		
		min	med.	max	min	med.	max	min	med.	max
LINEO 100 QUIET	17160									
LINEO 100 T QUIET	17190	44.6	52.9	57.1	44.8	51.2	56.9	15.7	21.3	26.1
LINEO 125 QUIET	17161									
LINEO 125 T QUIET	17191	42.6	46.7	52.9	43	46.6	53.4	15.6	21.1	25
LINEO 150 QUIET	17162									
LINEO 150 T QUIET	17192	42.8	50.7	59.7	44.5	50.1	58.5	17.6	22.9	30.7
LINEO 160 QUIET	17163									
LINEO 160 T QUIET	17193	42.8	50.7	59.7	44.5	50.1	58.5	17.6	22.9	30.7
LINEO 200 QUIET	17164									
LINEO 200 T QUIET	17194	59.3	65.8	68.8	57.6	64	67.5	31	36.9	40.2
LINEO 250 QUIET	17165	58.8	67.6	71.5	57.5	65.9	69.9	29	36.5	40.1
LINEO 315 QUIET	17166	66.8	71	74.2	65.3	69.5	72.3	38.3	42.4	45.4

\* calculated in free field conditions at 3 m distance







### DIMENSIONS - LINEO QUIET

Models	Code	A	B	C	Ø D	E	F	G	H	L	Ø M	N	VERSION
LINEO 100 QUIET	17160	210	294.5	639	97	130	235	135	120	67.5	5.5	320	A
LINEO 100 T QUIET	17190												
LINEO 125 QUIET	17161	210	294.6	504.5	122	130	235	135	120	67.5	5.5	320	A
LINEO 125 T QUIET	17191												
LINEO 150 QUIET	17162	232	320.5	685	147	145	261.5	170	132	85	5.5	360	A
LINEO 150 T QUIET	17192												
LINEO 160 QUIET	17163	232	320.5	570	156.5	145	261.5	170	135	85	5.5	360	A
LINEO 160 T QUIET	17193												
LINEO 200 QUIET	17164	322.5	417.5	625.5	194.5	195	363.5	190	120	155	5.5	510	B
LINEO 200 T QUIET	17194												
LINEO 250 QUIET	17165	318	412	751.5	243	189.5	363.5	200	70	170	6.5	604.5	B
LINEO 315 QUIET	17166												

### VERSION A

LINEO 100 QUIET - LINEO 100 T QUIET - LINEO 125 QUIET - LINEO 125 T QUIET  
LINEO 150 QUIET - LINEO 150 T QUIET - LINEO 160 QUIET - LINEO 160 T QUIET

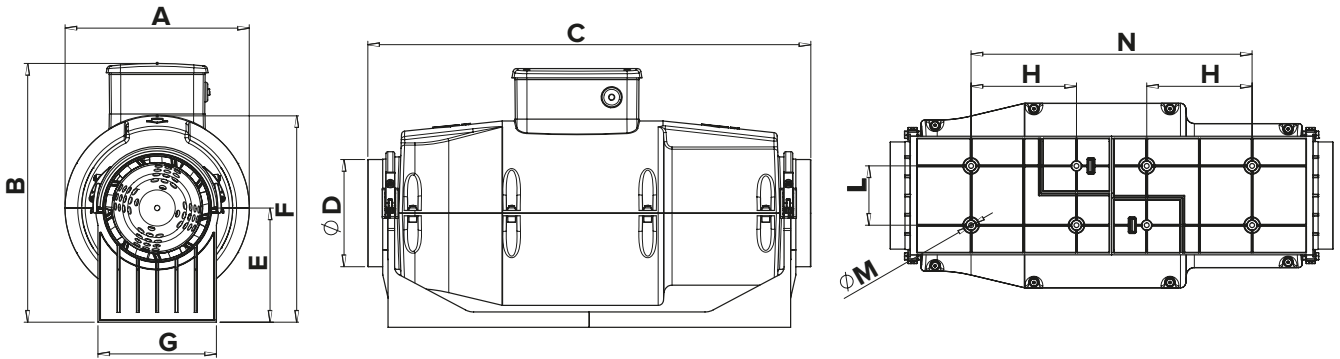

### VERSION B

LINEO 200 QUIET - LINEO 200 T QUIET - LINEO 250 QUIET - LINEO 315 QUIET

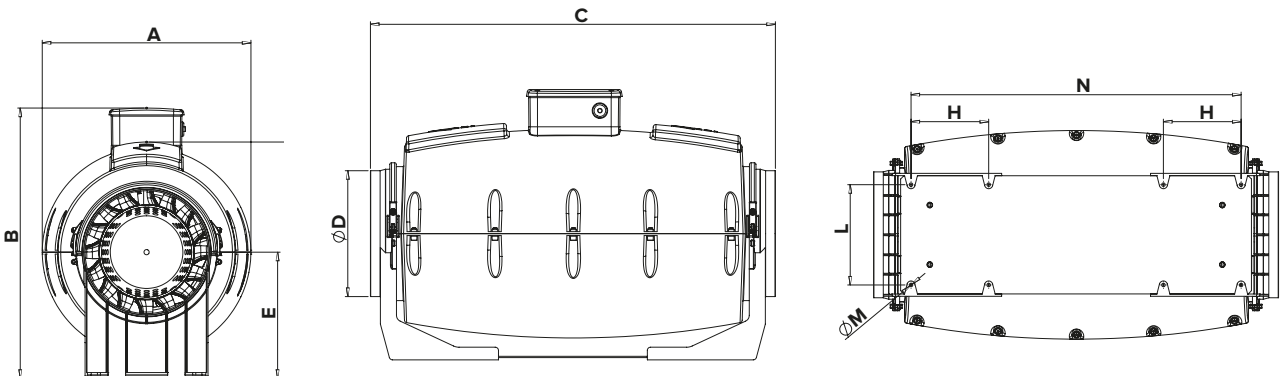

# LINEO QUIET ES RANGE

## IN-LINE MIXED FLOW FANS





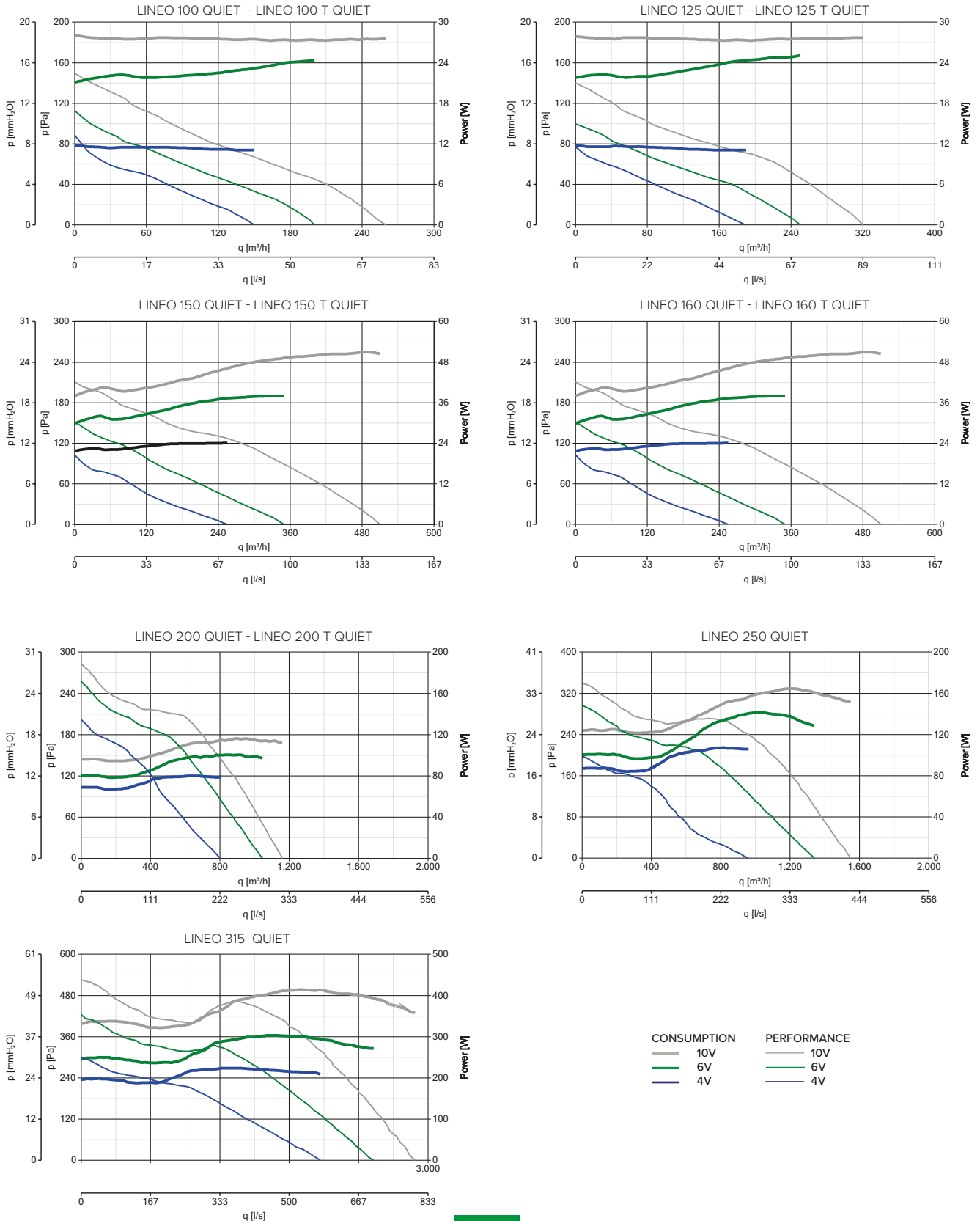



NEW

### PERFORMANCE AND ABSORPTION CURVES - LINEO QUIET





## CONTROLLERS - LINEO QUIET

MODELS	DESCRIPTION	CODE	PRODUCT
	<b>C5 0.5</b> - 5 SPEED CONTROLLER	12987	17160 - 17161 - 17162 - 17163 - 17164 17165 - 17166
	<b>C 1.5</b> - ELECTRONIC SPEED CONTROLLER 1.5 A	12966	17160 - 17161 - 17162 - 17163 - 17164 17165 - 17166
	<b>C 2.5</b> - ELECTRONIC SPEED CONTROLLER 2.5 A	12967	17165 - 17166
	<b>KIT SCB5</b> - CONVERTS SCR5 TO A BUILT-IN VERSION	22483	12987 - 12966 - 12967
	<b>KIT SCB</b> - BUILT-IN CONTROLLER ADAPTOR	22481	12987 - 12966 - 12967
	<b>TRIO-LINEO 503</b> - 3 SPEED SELECTOR	12891	17160 - 17161 - 17162 - 171763 - 17164 17165 - 17166 - 17190 - 17191 17192 17193 - 17194
	<b>C TEMP</b> - TEMPERATURE SENSOR	12992	ALL PRODUCTS
	<b>C SMOKE</b> - AIR QUALITY SENSOR	12993	ALL PRODUCTS
	<b>C HCS</b> - RELATIVE HUMIDITY SENSOR	12994	ALL PRODUCTS
	<b>C PIR</b> - PASSIVE INFRARED SENSOR	12998	ALL PRODUCTS
	<b>C TIMER</b> - TIMER	12999	ALL PRODUCTS

LINEO RANGE  
IN-LINE MIXED FLOW FANS

NEW

# LINEO RANGE

In-line mixed flow fans

The **LINEO** range products are fitted with multi speed induction motors.

**THE BEST COMPROMISE AMONG  
PERFORMANCE, POWER CONSUMPTION  
AND NOISE EMISSION.**





# EASY AND FLEXIBLE INSTALLATION

## KEY FEATURES

- Complete range, 26 models with a nominal diameter between 100 mm and 315 mm, 18 equipped with AC motors and 8 equipped with brushless EC motors.
- With or without timer and silenced.
- Flexibility and ease of installation ideal for your specific performance-related requirements, consumption, needs and operating costs.



easy

# MAINTENANCE

## ELECTRIC BOX

Produced in a material granting electrical and fire resistance

## INLET NOZZLE

Dimensioned to sustain the product in the wall and ceiling installation



## DIVERGENT ELEMENT

It helps the impeller to increase the performance

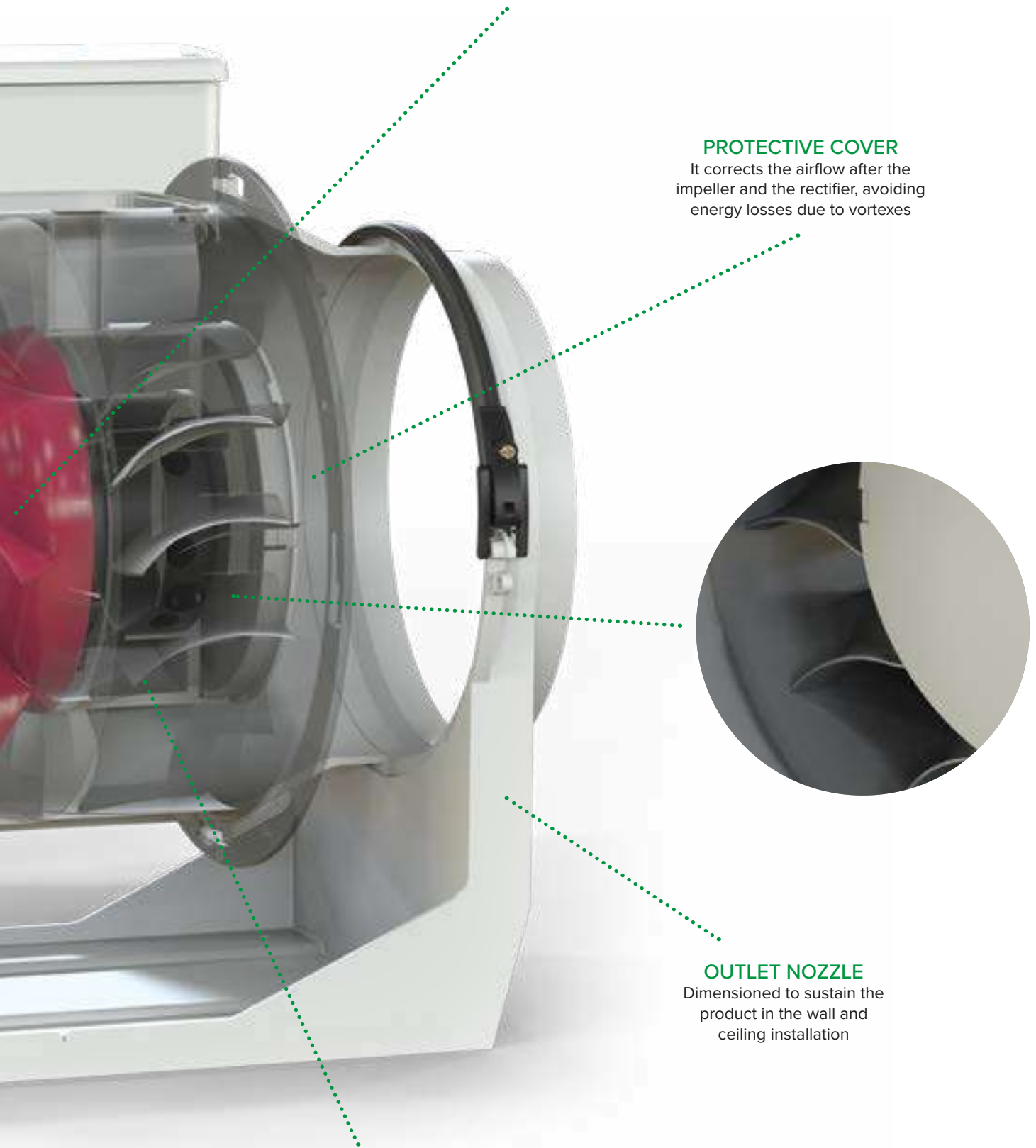

**IMPELLER**

Designed to reach the ERP efficiency levels

**PROTECTIVE COVER**

It corrects the airflow after the impeller and the rectifier, avoiding energy losses due to vortices



**OUTLET NOZZLE**

Dimensioned to sustain the product in the wall and ceiling installation

**RECTIFIER BLADES**

Designed with the impeller to rectify the airflow and avoid flow problems on the downstream part of the product



**LINEO RANGE**  
IN-LINE MIXED FLOW FANS EQUIPPED WITH AC MOTORS

**NEW**

**TECHNICAL AND PERFORMANCE DATA - LINEO\***

Models	Code	V ~ 50/60HZ	W min/max	A min/max	RPM min/max	Max Airflow		Max Pressure		Sound Pressure Lp dB (A)**	Protection grade***	Max °C	KG
						m³/h min/max	l/s min/max	mmH₂O min/max	Pa min/max				
LINEO 100	17144	220-240	20	0.09	1520	180	50	13	127.5	30.7	IP44	60	1.8
LINEO 100 T	17185		23	0.11	2030	255	70.8	16.5	161.9	39.4			
LINEO 100 Q	17143	220-240	12	0.05	1860	155	43.1	6.5	63.8	29.4	IP44	60	1.8
LINEO 100 Q T	17184		15	0.9	2450	200	55.6	7.5	73.6	37.9			
LINEO 125	17145	220-240	25	0.11	1570	250	69.4	13	127.5	33.9	IP44	60	1.8
LINEO 125 T	17186		33	0.15	2140	365	101.4	17	166.8	43			
LINEO 150	17146	220-240	40	0.18	1580	385	106.9	21	206	41.4	IP44	60	2.5
LINEO 150 T	17187		58	0.26	2100	550	152.8	27	264.9	50.5			
LINEO 160	17147	220-240	40	0.18	1580	385	106.9	21	206	41.7	IP44	60	2.8
LINEO 160 T	17188		58	0.26	2100	550	152.8	27	264.9	50.8			
LINEO 200 Q	17148	220-240	45	0.22	1780	700	194.4	13	127.5	39.6	IP44	60	4.3
LINEO 200 Q T	17189		75	0.37	2740	950	263.9	29	284.5	49.0			
LINEO 250 Q	17149	220-240	85	0.40	1850	720	200	34	333.5	49.1	IP44	60	5.9
LINEO 250 Q T	17197		110	0.50	2550	990	275	53	519.9	56.2			

\* All data referred to supply at 50 Hz

\*\* Calculated in free field conditions at 3 m distance

\*\*\* Protection referred to ducted units

Models	Code	V ~ 50 HZ	W min/med/ max	A min/med/ max	RPM min/med/ max	Max Airflow		Max Pressure		Protection grade***	Max °C	KG
						m³/h min/med/max	l/s min/med/max	mmH₂O min/med/max	Pa min/med/max			
<b>NEW</b> LINEO 200	17180	220 - 240	80	0.34	1925	815	226.4	21.5	210.9	IPX5	50	4.9
<b>NEW</b> LINEO 200 T	17177		95	0.42	2450	1025	284.7	27.3	267.7			
<b>NEW</b> LINEO 250	17181	220 - 240	90	0.41	1500	725	201	13.9	136.5	IPX5	50	5.3
			120	0.54	2240	1145	318	29	284.4			
			145	0.63	2730	1440	400	37.2	364.8			
<b>NEW</b> LINEO 315	17182	220 - 240	190	1.14	1770	1590	442	27.1	265.8	IPX5	50	9.5
			260	1.57	2300	2115	588	42.2	413.9			
			360	1.60	2690	2590	719	55.4	543.3			

**SUOND LEVELS - LINEO 200 - 250 - 315**

Models	Code	SOUND POWER Lw dB (A)								
		INTAKE			SUPPLY			BREAKOUT		
		min	med.	max	min	med.	max	min	med.	max
LINEO 200	17180	80	86.4	89.5	78.6	74.9	88.2	57.4	63.7	67.5
LINEO 200 T	17177									
LINEO 250	17181	73.6	83.3	88.2	72.2	81.7	86.4	52.4	60	64
LINEO 315	17182	82.6	88.7	92	82	88.2	91.8	60.1	66.3	69.5

Models	Code	SOUND PRESSURE LP dB(A)*								
		INTAKE			SUPPLY			BREAKOUT		
		min	med.	max	min	med.	max	min	med.	max
LINEO 200	17180	62.5	68.8	72	61.1	67.4	70.7	36.9	43.1	46.9
LINEO 200 T	17177									
LINEO 250	17181	56.1	65.8	70.7	54.6	64.2	68.8	31.9	39.5	43.5
LINEO 315	17182	65	71.1	74.5	64.5	70.6	74.2	39.6	45.8	49

\* Calculated in free field conditions at 3 m distance







### DIMENSIONS - LINEO

Models	Code	A	B	C	Ø D	E	F	G	H	L	Ø M	N
LINEO 100	17144	188.5	211	303	96	101.5	189	90	60	80	5.5	-
LINEO 100 T	17185	188.5	211	303	96	101.5	189	90	60	80	5.5	-
LINEO 100 Q	17143	156	174	231	96	82	152	95	51.5	47.5	4.5	-
LINEO 100 Q T	17184	156	174	231	96	82	152	95	51.5	47.5	5.5	-
LINEO 125	17145	188.5	211	258	122	101.5	189	90	60	80	5.5	-
LINEO 125 T	17186	188.5	211	258	122	101.5	189	90	60	80	5.5	-
LINEO 150	17146	214.5	234	294	146	112.5	212	110	60	80	5.5	-
LINEO 150 T	17187	214.5	234	294	146	112.5	212	110	60	80	5.5	-
LINEO 160	17147	214.5	234	272.5	156	112.5	212	110	60	80	5.5	-
LINEO 160 T	17147	214.5	234	272.5	156	112.5	212	110	60	80	5.5	-
LINEO 200	17180	270	373	396	194.5	195	330	190	120	155	5.5	-
LINEO 200 T	17177	270	373	396	194.5	195	330	190	120	155	5.5	280
LINEO 200 Q	17148	234.5	266	300	196	125.5	235	140	94	100	5.5	-
LINEO 200 Q T	17189	234.5	266	300	196	125.5	235	140	94	100	5.5	-
LINEO 250	17181	300	378	322	243	190	329	200	70	170	5.5	174.5
LINEO 250 Q	17149	300	322	385	247	152.5	292	176.5	140	145	5.5	-
LINEO 250 Q T	17189	300	322	385	247	152.5	292	176.5	140	145	5.5	174.5
LINEO 315	17182	373	446	420	307	224	398	309	110	255	8.5	259.5

### VERSION A

LINEO 100 - LINEO 100 T - LINEO 125 - LINEO 125 T - LINEO 150 - LINEO 150 T  
LINEO 160 - LINEO 160 T - LINEO 200 Q - LINEO 200 Q T - LINEO 250 Q - LINEO 250 Q T

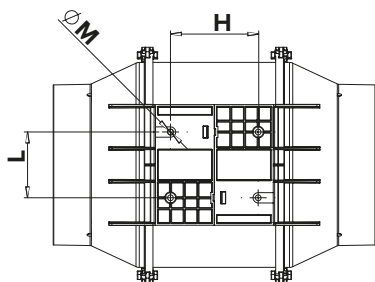

### VERSION B

LINEO 100 Q  
LINEO Q T

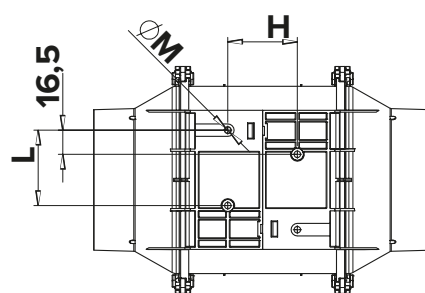

### VERSION C

LINEO 200 - LINEO 200 T - LINEO 250 - LINEO 315

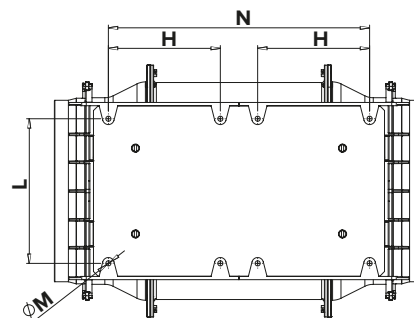
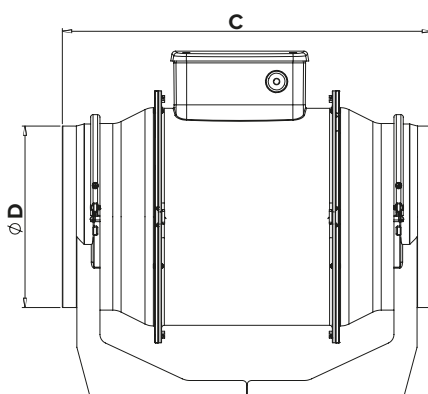
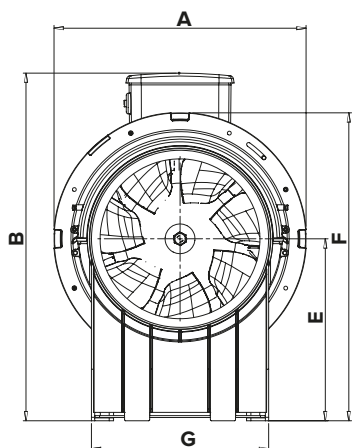

# LINEO RANGE

## IN-LINE MIXED FLOW FANS EQUIPPED WITH AC MOTORS

NEW

### PERFORMANCE AND ABSORPTION CURVES - LINEO

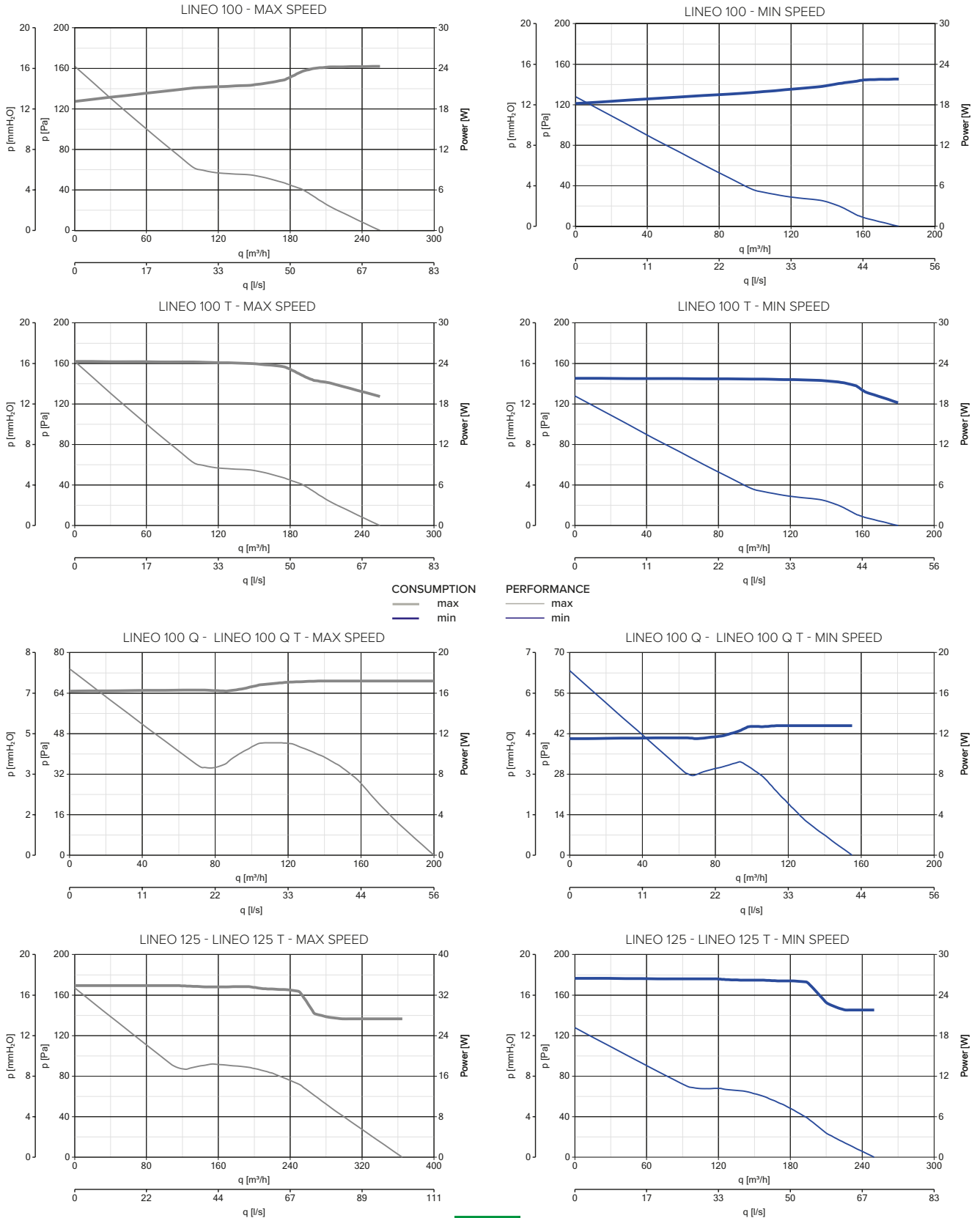



### PERFORMANCE AND ABSORPTION CURVES - LINEO

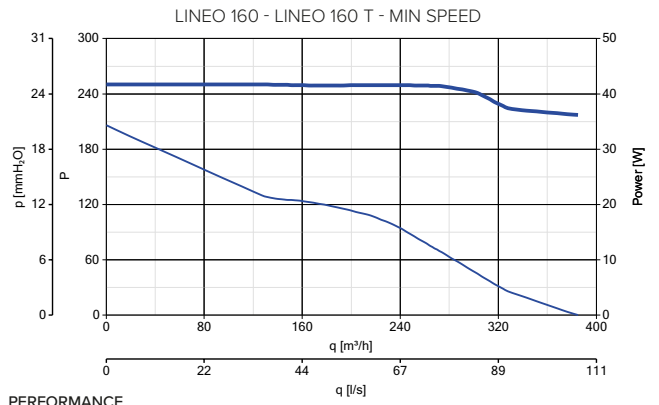
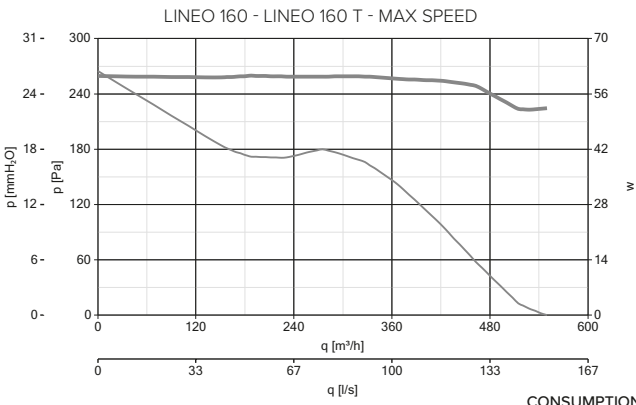
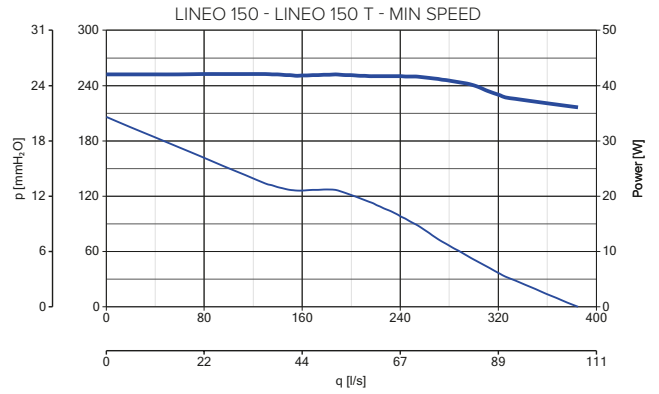
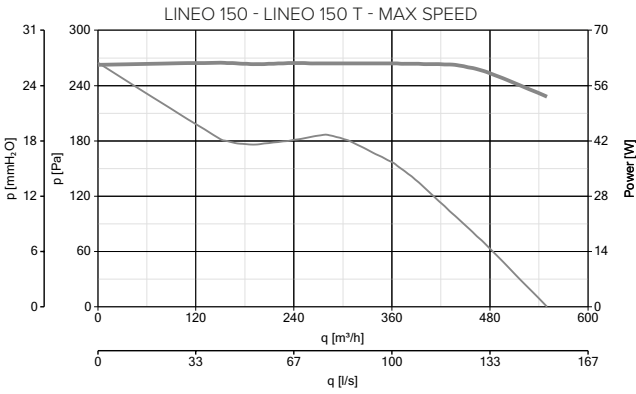

CONSUMPTION  
— max  
— min

PERFORMANCE  
— max  
— min

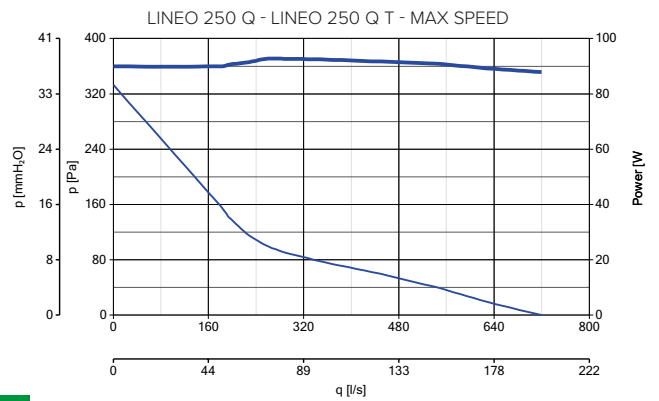
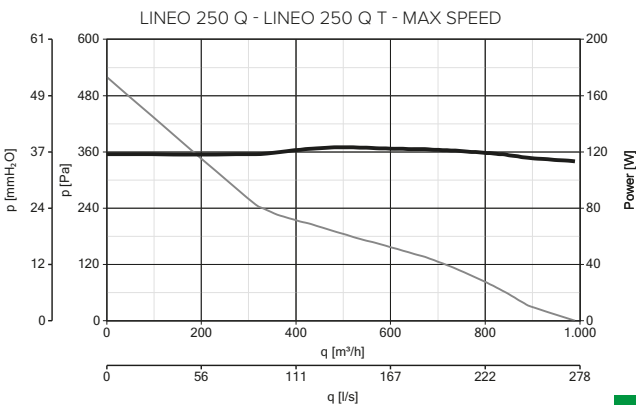
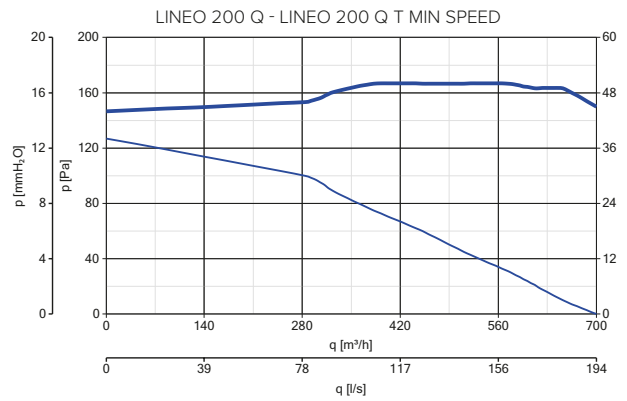
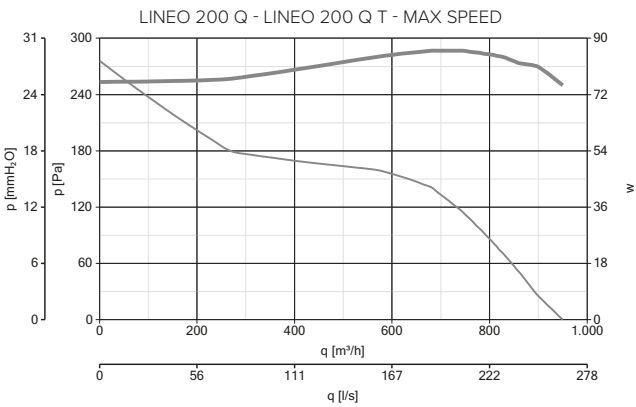

**LINEO RANGE**  
IN-LINE MIXED FLOW FANS EQUIPPED WITH AC MOTORS

**NEW**

**PERFORMANCE AND ABSORPTION CURVES - LINEO**

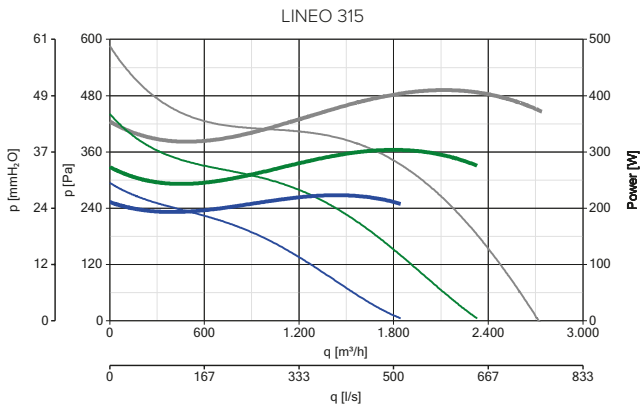
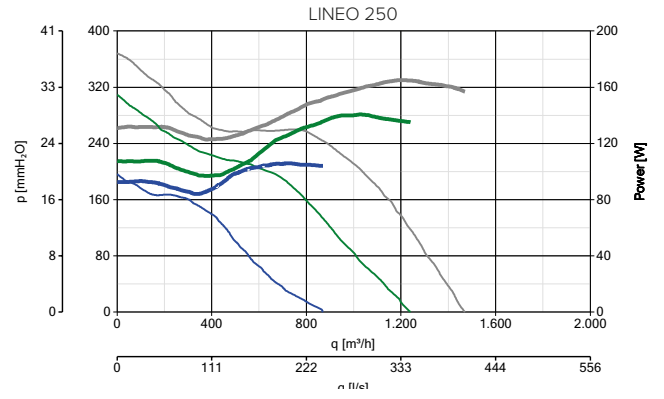
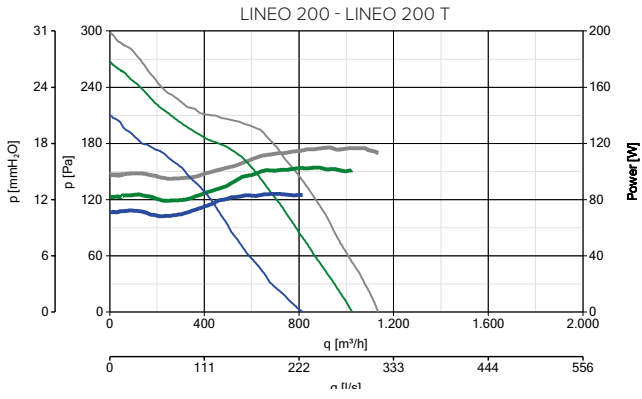

<b>CONSUMPTION</b>	<b>PERFORMANCE</b>
— MAX	— MAX
— MID	— MID
— MIN	— MIN





**LINEO ES RANGE**  
IN-LINE MIXED FLOW FANS EQUIPPED WITH EC BRUSHLESS MOTORS

**NEW**

**TECHNICAL AND PERFORMANCE DATA - LINEO ES**

Models	Code	V ~ 50/60HZ	W 4/6/8/10V	A 4/6/8/10V	RPM 4/6/8/10V	Max Airflow		Max Pressure		Protection grade***	Max °C	KG
						m³/h	l/s	mmH₂O	Pa			
						4/6/8/10V	4/6/8/10V	4/6/8/10V	4/6/8/10V			
LINEO 100 ES	17159	220 - 240	6.5	0.07	1070	140	38.9	3.7	36.3	IP45	60	2.3
			8.7	0.09	1345	175	48.6	6.1	59.8			
			16	0.15	1900	250	250	11.4	111.8			
			20	0.20	2220	305	84.7	26.4	258.9			
LINEO 100 Q ES	17158	220 - 240	4.5	0.05	900	60	16.7	0.9	8.8	IP45	60	1.8
			5.5	0.06	1235	80	22.2	1.7	16.7			
			9	0.08	2070	145	40.3	4.3	42.2			
			19	0.18	3230	235	65.3	9.8	96.1			
LINEO 125 ES	17178	220 - 240	7	0.07	1090	170	47.2	3.8	37.3	IP45	60	2.2
			10	0.10	1395	220	61.1	6.5	63.7			
			18	0.17	1940	315	87.5	11.8	115.7			
			25	0.25	2270	370	102.8	30.2	296.2			
LINEO 150 ES	17179	220 - 240	11	0.10	1260	290	80.6	8.5	83.4	IP45	60	2.6
			17	0.16	1595	370	102.8	13.8	135.3			
			34	0.30	2125	500	138.9	22.7	222.6			
			55	0.50	2480	590	163.9	44.2	433.5			
LINEO 160 ES	17183	220 - 240	12	0.11	1305	300	83.3	9	9	IP45	60	2.7
			19	0.17	1645	385	106.9	14.8	145.1			
			37	0.33	2165	510	141.7	23.5	230.5			
			60	0.55	2625	630	175	47.2	462.9			
NEW LINEO 200 ES	17167	220 - 240	15.8	0.19	1380	560	155.6	9.2	90.2	IP45	50	4.6
			25.7	0.28	1700	700	194.4	14.4	141.2			
			52.8	0.53	2220	920	255.6	24	235.4			
			90	0.80	2680	1100	305.6	34.9	342.4			
NEW LINEO 250 ES	17168	220 - 240	20	0.17	2270	755	209.7	11	107.9	IP45	50	5
			35	0.28	1695	935	259.7	16.9	165.7			
			75	0.61	1370	1235	343.1	28.9	283.4			
			126	1.00	2680	1475	409.7	40.4	396.2			
NEW LINEO 315 ES	17169	220 - 240	45	0.37	1300	1415	393.1	14.6	143.2	IP45	50	9.2
			75	0.63	1600	1740	393.1	21.9	214.8			
			170	1.32	2130	2320	483.3	38.6	378.6			
			230	1.75	2370	2625	729.2	43	421.7			

\* All data referred to supply at 50 Hz

\*\*\* Protection referred to ducted units

**SOUND LEVELS - LINEO ES**

**SOUND POWER Lw dB (A)**

Models	Code	INTAKE				SUPPLY				IRRADIATED			
		4V	6V	8V	10V	4V	6V	8V	10V	4V	6V	8V	10V
LINEO 100 ES	17159	63.3	69.4	78.2	82.6	62.1	68.4	77.5	82	35.5	39.5	47.8	52.3
LINEO 100 Q ES	17158	57.8	64.9	75.1	85.7	54.9	64.9	73.5	85.7	35.1	37.4	47.5	56.6
LINEO 125 ES	17178	64.1	68.2	76.7	81.4	63.6	68.6	77.5	81.5	36.8	40.5	48.8	52.2
LINEO 150 ES	17179	67.9	74.6	82.1	87.9	69.6	75.2	82.1	86.4	41.5	47.8	56.1	62.5
LINEO 160 ES	17183	68.4	76.4	83.1	87.5	69.1	76	82.8	86.9	42.4	49.4	57	62.3
LINEO 200 ES	17167	78.5	83.9	86.9	89.4	77.5	82.9	85.4	88.4	55.6	60.4	62.8	65
LINEO 250 ES	17168	74.2	79.1	85.1	88.9	74.4	79.2	84.9	88.5	49.5	54.3	61.4	64
LINEO 315 ES	17169	83.1	88	90.7	92.8	80.8	88.2	88.8	90	63	64.6	65.3	68.1

**SOUND PRESSURE Lp dB(A)\***

Models	Code	INTAKE				SUPPLY				IRRADIATED			
		4V	6V	8V	10V	4V	6V	8V	10V	4V	6V	8V	10V
LINEO 100 ES	17159	45.8	51.9	60.7	65.1	44.6	50.9	59.9	64.4	15	18.9	27.2	31.8
LINEO 100 Q ES	17158	40.2	47.3	57.6	68.2	37.3	47.4	56	68.1	14.6	16.9	27	36.1
LINEO 125 ES	17178	46.6	50.6	59.1	63.9	46	51.1	60	64	16.2	20	28.3	31.6
LINEO 150 ES	17179	50.4	57.1	64.6	70.3	52.1	57.7	64.5	68.9	21	27.2	35.5	41.9
LINEO 160 ES	17183	50.9	58.9	65.6	70	51.5	58.5	65.6	69.3	21.9	28.9	36.5	41.8
LINEO 200 ES	17167	60.9	66.4	69.4	71.9	60	65.3	67.9	70.8	35.1	39.9	42.3	44.5
LINEO 250 ES	17168	56.7	61.5	67.6	71.3	56.9	61.6	67.3	71	29	33.7	40.9	43.4
LINEO 315 ES	17169	65.6	70.4	73.2	75.3	63.3	70.6	71.2	72.4	42.5	44	44.8	47.5

\* Calculated in free field conditions at 3 m distance





### DIMENSIONS - LINEO ES

Models	Code	A	B	C	Ø D	E	F	G	H	L	Ø M	N
LINEO 100 ES	17159	188.5	240	303	96	101.5	189	90	60	80	5.5	-
LINEO 100 Q ES	17158	156	205	231	96	82	152	95	51.5	47.5	4.5	-
LINEO 125 ES	17178	188.5	240	258	122	101.5	189	90	60	80	5.5	-
LINEO 150 ES	17179	214.5	265	294	146	112.5	212	110	60	80	5.5	-
LINEO 160 ES	17183	214.5	265	272.5	156	112.5	212	110	60	80	5.5	-
LINEO 200 ES	17167	270	372.5	396	194.5	195	330	190	120	155	5.5	280
LINEO 250 ES	17168	300	377.5	322	243	190	329	200	70	170	6.5	174.5
LINEO 315 ES	17169	373	506	420	307	224	398	309	110	255	8.5	259.5

### VERSION A

LINEO 100 ES - LINEO 125 ES  
LINEO 150 ES - LINEO 160 ES

### VERSION B

LINEO 100 Q ES

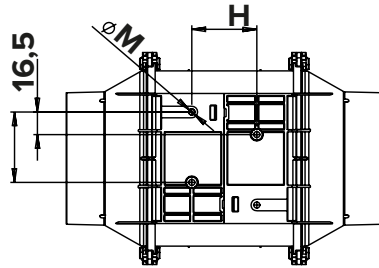
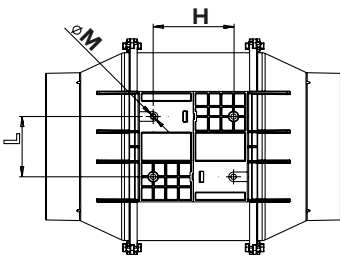

### VERSION C

LINEO 200 ES - LINEO 250 ES - LINEO 315 ES

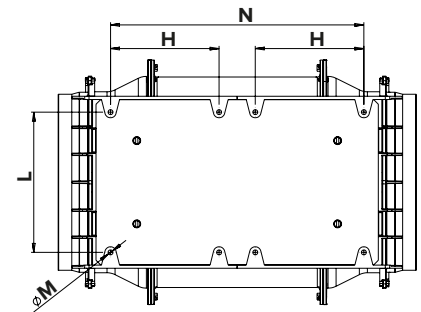
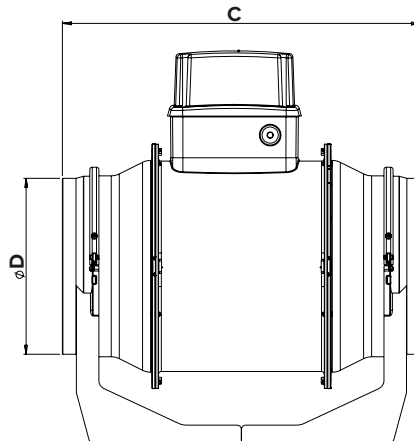
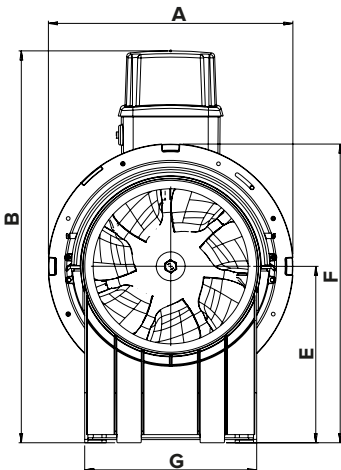

**LINEO ES RANGE**  
IN-LINE MIXED FLOW FANS EQUIPPED WITH EC BRUSHLESS MOTORS

**NEW**



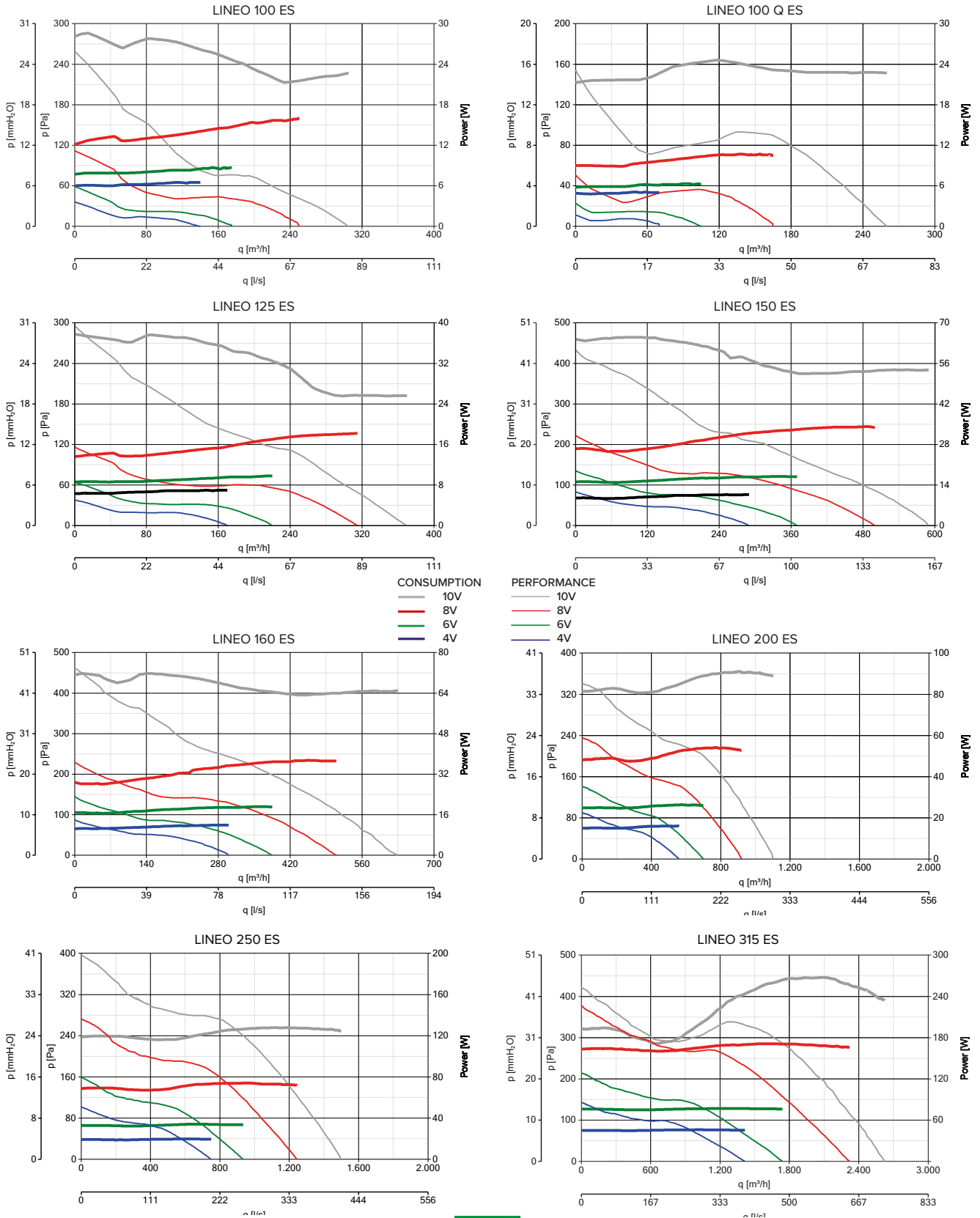







**PERFORMANCE AND ABSORPTION CURVES - LINEO ES**











## CONTROLLERS - LINEO

MODELS	DESCRIPTION	CODE	PRODUCT
	<b>C5 0.5</b> - 5 SPEED CONTROLLER	12987	17180
	<b>C 1.5</b> - ELECTRONIC SPEED CONTROLLER 1.5 A	12966	17180
	<b>C 2.5</b> - ELECTRONIC SPEED CONTROLLER 2.5 A	12967	17181 - 17182
	<b>KIT SCB5</b> - CONVERTS SCR5 TO A BUILT-IN VERSION	22483	12987 - 12966 - 12967
	<b>KIT SCB</b> - BUILT-IN CONTROLLER ADAPTOR	22481	12987 - 12966 - 12967
	<b>POT-IT</b> - POTENTIOMETER COMPATIBLE WITH FLUSH MOUNTING IN UNI 503 ELECTRIC BOX	12826	17158 - 17159 - 17179 - 17183 - 17187 17167 - 17168 - 17169
	<b>POT</b> - POTENTIOMETER COMPATIBLE WITH FLUSH MOUNTING IN DIN ELECTRIC BOX	12828	17158 - 17159 - 17179 - 17183 - 17187 17167 - 17168 - 17169
	<b>TRIO-LINEO 503</b> - 3 SPEED SELECTOR	12891	17181 - 17177 - 17182
	<b>DUO</b> - 2 SPEED SELECTOR	22914	17144 - 17185 - 17143 - 17184 - 17145 17186 - 17146 - 17187 - 17147 - 1718 17148 - 17189 - 17149 - 17197
	<b>C TEMP</b> - TEMPERATURE SENSOR	12992	ALL PRODUCTS
	<b>C SMOKE</b> - AIR QUALITY SENSOR	12993	ALL PRODUCTS
	<b>C HCS</b> - RELATIVE HUMIDITY SENSOR	12994	ALL PRODUCTS
	<b>C PIR</b> - PASSIVE INFRARED SENSOR	12998	ALL PRODUCTS
	<b>C TIMER</b> - TIMER	12999	ALL PRODUCTS

## ACCESSORIES ON REQUEST - LINEO

MODELS	DESCRIPTION	CODE	PRODUCT
		100	22584
	<b>LINEO-C</b> - IN-LINE INSTALLATION KITS	125	22585
		150	22586
		160	22587
		100	22577
	<b>LINEO-PF</b> - SIDE BY SIDE INSTALLATION KITS	125	22578
		150	22579
		160	22581
	<b>LINEO-SF 500</b> - BRACKET FOR IN-LINE APPLICATION	22593	17143 - 17184 - 17144 - 17185 - 17159 17158 - 17145 - 17186 - 17178 - 17146 17187 - 17179 - 17147 - 17188 - 17183 17148 - 17189 - 17180 - 17177 - 17167
	<b>LINEO-SF 700</b> - BRACKET FOR IN-LINE APPLICATION	22594	17149 - 17197 - 17168 - 17169
		100	22701
		125	22702
		150	22703
		160	22704
		200	22705
		250	22706
	<b>LINEO-G</b> - PROTECTION GRILLE	315	22707
			17143 - 17184 - 17144 17185 - 17159 - 17158 17145 - 17186 - 17178 17146 - 17187 - 17179 17147 - 17188 - 17183 17148 - 17189 - 17180 - 17177 - 17167 17149 - 17197 - 17168
			17159 - 17158 17178 17179 17183 17159 - 17158 17178 17179 17183 17143 - 17184 - 17144 - 17185 - 17159 17158 - 17145 - 17186 - 17178 - 17146 17187 - 17179 - 17147 - 17188 - 17183 17148 - 17189 - 17180 - 17177 - 17167 17149 - 17197 - 17168 - 17169

## **CA VO RANGE**

In-line centrifugal fans in self-extinguishing plastic



Self-extinguishing plastic resin mixed flow duct fans, installed in false ceilings or in attics. The ideal low-visual impact ventilation solution for residential, commercial or industrial premises (kitchens, toilets, laboratories, bars, restaurants, laundries, shops, etc.).

### **VERSIONS**

7 models, with nominal diameter between 100 and 315 mm.

### **KEY FEATURES**

- Built to withstand aggressive agents.
- Standard supplied support brackets.
- High protection rating from dust and water for safe use in industrial environments.
- Wide continuous operation temperature range (-25 °C / + 50 °C).
- Can be installed horizontally, vertically or sloping.
- Fully compliant with Reg. ErP 2018 N. 1253/2014

### **TECHNICAL FEATURES**

- Casing built into the boxes containing the mains connection terminals and the flow conditioner fins, constructed in self-extinguishing plastic resin (V0).
- 3-speed fans that can be set using optional device TRIO-CA (code 12869), composed of:
  - AC motors with thermal overload cut-out and shafts turning on ball bearings to guarantee long lasting continuous service (at least 30,000 h) at the maximum plate temperature.
  - Backward-curve, heat resistant plastic resin blade impellers loaded with glass fibre to combine structural strength and dimensional stability.
  - Galvanised steel sheet brackets for wall, ceiling and false ceiling installation.
- Possibility of connecting to remote environmental temperature, humidity, smoke and presence sensors (optional).
- Protection rating from dusts and water: IP44 (appliance ducted in extraction and delivery).
- Insulation Class: II .

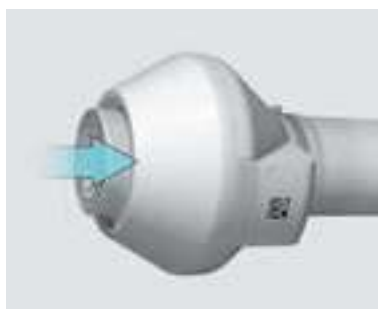
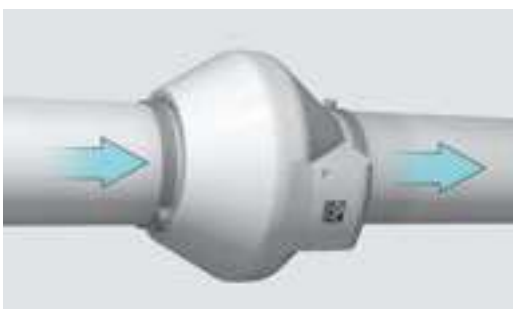



## TECHNICAL DATA

Models	Code	V~50/60HZ	W	A	RPM	Max Airflow		Max Pressure		LP DB(A) 3m	Max °C	KG	
						min/med/max	min/med/max	min/med/max	min/med/max				min/med/max
CA100 V0 D	16008	220-240	14	0.14	1660	85	24	27	269	51	50	2.4	
			27	0.19	-	156	43	36	360	-			
			50	0.22	2400	251	69.7	37	366	56*			
CA125 V0 D	16018	220-240	14	0.14	1480	107	29	19	195	45	50	2.3	
			27	0.19	-	200	55	33	333	-			
			52	0.22	2400	300	83	34.7	340	56*			
CA150 V0 D	16028	220-240	14	0.14	1400	150	41	8.4	83	44	50	2.6	
			27	0.19	-	275	76	24	241	-			
			52	0.22	2400	460	128	31.8	312	56*			
CA200 V0 Q	16035	220-240	35	0.35	-	310	87	22	215	-	50	3.1	
			48	0.40	-	415	115	35	351	-			
			104	0.45	2355	805	224	44.7	438	59*			
CA200 V0 E	16038	220-240	39	0.35	1320	387.1	107.5	24.6	241.2	-	50	3.5	
			58	0.40	2015	605	-	39.2	392	-			
			90	0.40	2611	775	215.3	42.2	413.9	50.3**			
CA250 V0 E	16039	220-240	45	0.37	1600	525	145.8	22.2	218	-	50	3.7	
			62	0.39	2190	730	202	35	344	-			
			90	0.40	2610	855	237.5	38.1	373.3	49.9**			
CA315 V0 E	16041	220-240	48	0.48	1280	527	146.3	27.5	270	-	55	5.5	
			80	0.57	1970	825	229	50	488	-			
			120	0.54	2640	1100	305.5	56.6	554.7	54**			
<b>NEW</b>	CA315 V0 SE	16090	220-240	195	0,85	2790	1560	433	66	649	64	45	6.6

\* Sound pressure level measured at 3 m in free field conditions with long-cased appliance in delivery mode in accordance with standard EN ISO 3741.

\*\* Sound pressure level measured at 3 m in free field conditions with long-cased appliance in delivery mode in accordance with standard EN ISO 9614.

## CA V0 RANGE

Available only for Extra EU market and therefore not in compliance with Reg. ErP 2018

- 4 models, with nominal diameter between 100 and 200 mm.
- 1 or 2-speed (depending on the model) motors with thermal overload cut-out and shafts turning on ball bearings to guarantee long lasting continuous service (at least 30,000 h) at the maximum plate temperature. Speed adjustment using Vortice accessory devices.
- Performance and safety certified by third party body (IMQ).

### TECHNICAL DATA - AVAILABLE ONLY FOR EXTRA EU MARKET

Models	Code	V~50/60HZ	W	A	RPM	Max Airflow		Max Pressure		LP DB(A) 3m	Max °C	KG
						min/max	min/max	min/max	min/max			
CA100 V0 D*	16034	220-240	65 85	0,32 0,38	1660 2540	150 235	41,7 65,3	30 40	274 392	51 56**	50	2,4
CA125 V0 D*	16044	220-240	67 85	0,34 0,40	1480 2470	210 360	58,3 100	25 36	245 353	45 56**	50	2,3
CA150 V0 D*	16054	220-240	70 85	0,34 0,41	1400 2390	280 500	77,8 138,9	20 34	196 333	44 56**	50	2,6
CA200 V0 Q*	16064	220-240	100	0,35	2290	700	194,4	37	363	59**	50	4,1

\* Available only for Extra EU markets

\*\* Sound pressure level measured at 3 m in free field conditions with long-cased appliance in delivery mode in accordance with standard EN ISO 3741.

\*\*\* Sound pressure level measured at 3 m in free field conditions with long-cased appliance in delivery mode in accordance with standard EN ISO 9614.

**CA VORANGE**  
IN-LINE CENTRIFUGAL FANS IN SELF-EXTINGUISHING PLASTIC

**DIMENSIONS**

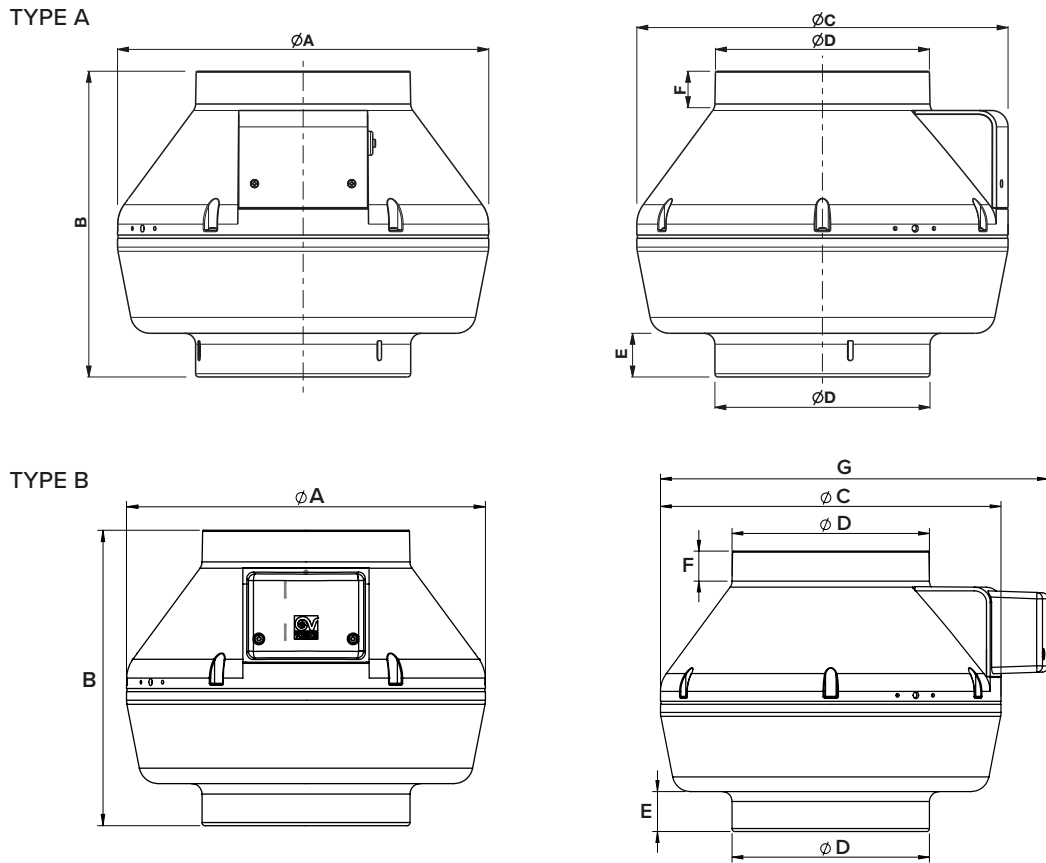

MODELS	$\varnothing A$	B	$\varnothing C$	$\varnothing D$	E	F	G
CA 100 V0 D (TYPE A)	250	250	250	97	30	30	-
CA 125 V0 D (TYPE A)	250	250	250	122	30	30	-
CA 150 V0 D (TYPE A)	300	305	300	147/157	30/30	30/60	-
CA 200 V0 Q (TYPE B)	340	280	340	197	40	30	390
CA 200 V0 E (TYPE B)	340	280	340	197	40	30	390
CA 250 V0 E (TYPE B)	340	305	340	247	60	30	390
CA 315 V0 E (TYPE B)	400	340	400	312	75	40	438
CA 315 V0 SE (TYPE B)	400	340	400	312	75	40	438

Dimensions (mm)

**AVAILABLE ONLY FOR EXTRA EU MARKET**

MODELS	$\varnothing A$	B	$\varnothing C$	$\varnothing D$	E	F
CA 100 V0 D (TYPE A)	250	250	250	97	30	30
CA 125 V0 D (TYPE A)	250	250	250	122	30	30
CA 150 V0 D (TYPE A)	300	305	300	147/157	30/60	30/60
CA 200 V0 Q (TYPE A)	340	280	340	197	40	30

Dimensions (mm)



PERFORMANCE CURVES

CA.100 V0\_D

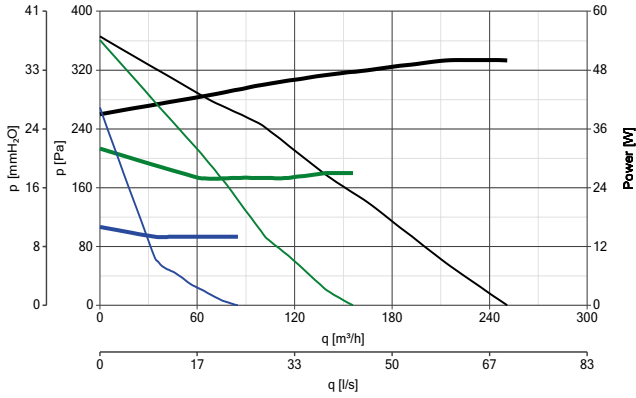

CA 125 V0 D

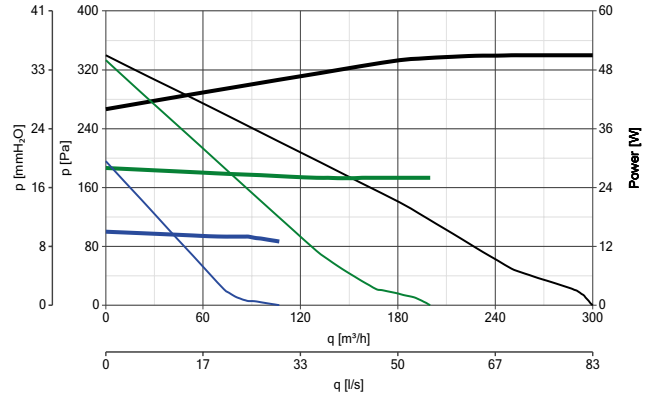

POWER CONSUMPTION  
 — max  
 — med  
 — min

PERFORMANCE CURVES  
 — max  
 — med  
 — min

CA 150 V0 D

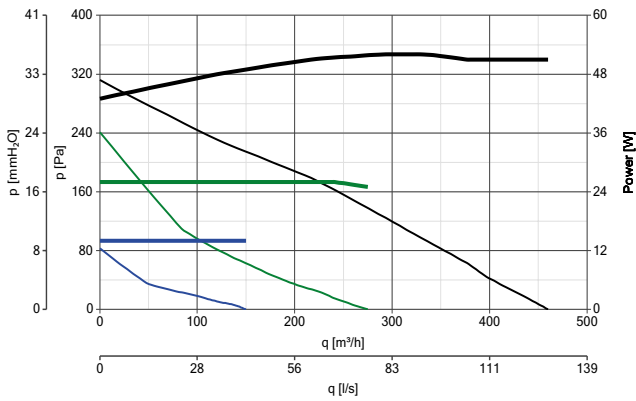

CA 200 V0 Q

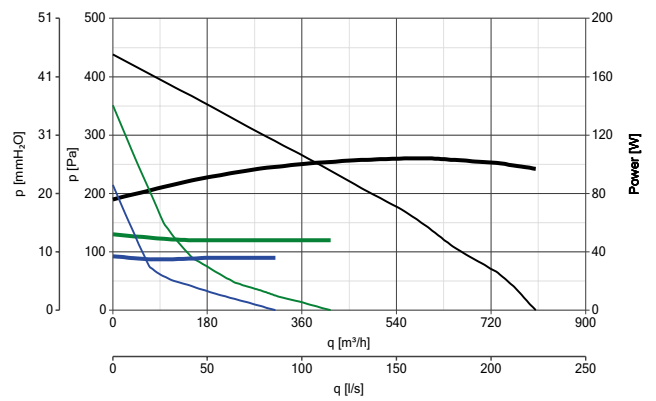

CA 200 V0 E

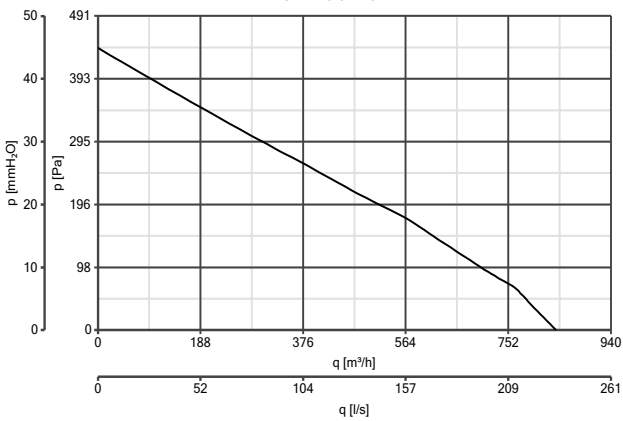

CA 250 V0 E

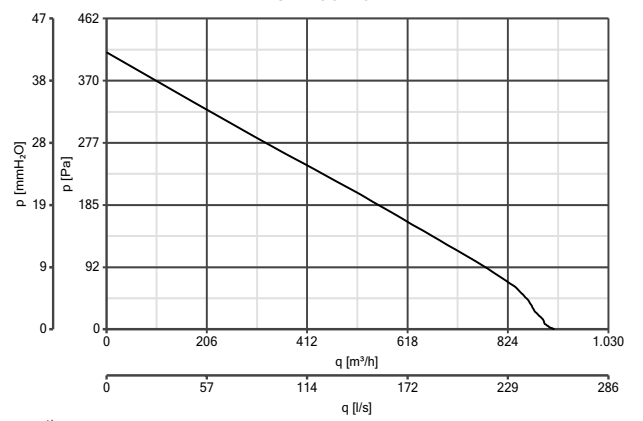

— Power consumption  
 — Performance curves



**CA V0 RANGE**  
IN-LINE CENTRIFUGAL FANS IN SELF-EXTINGUISHING PLASTIC

**PERFORMANCE CURVES**

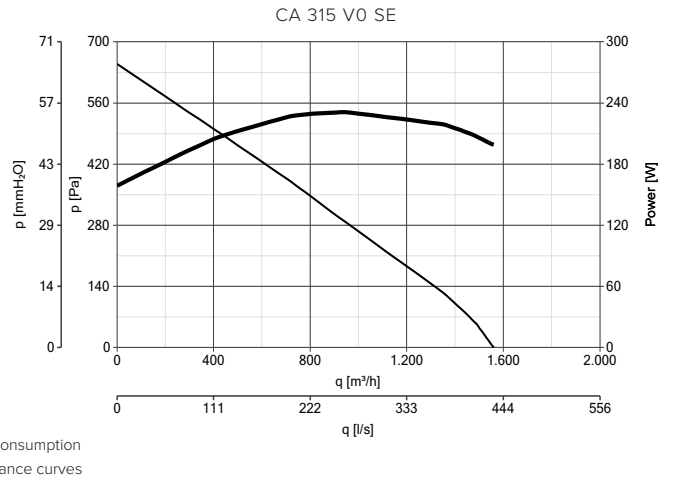
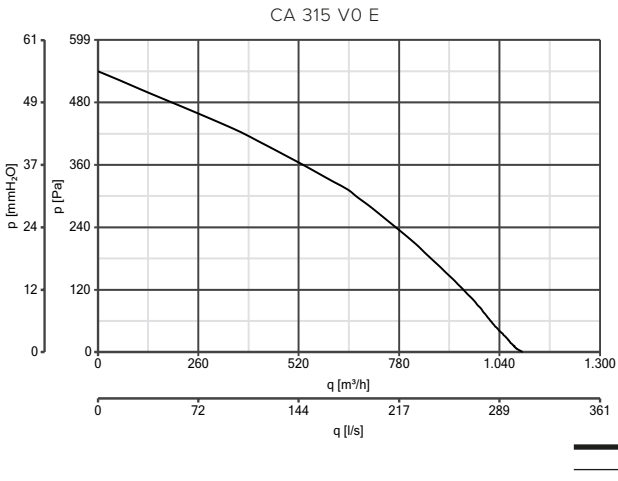



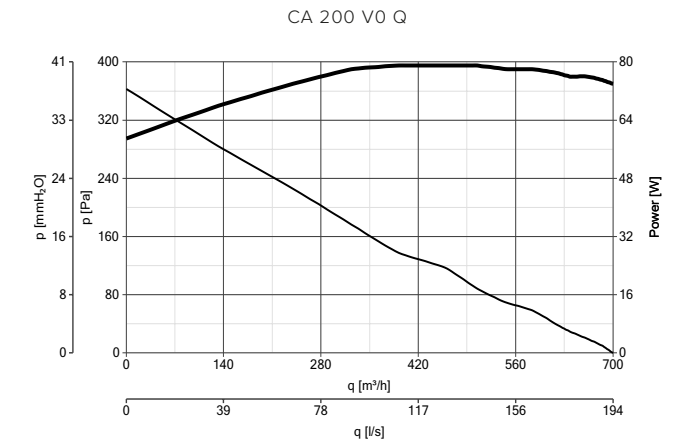
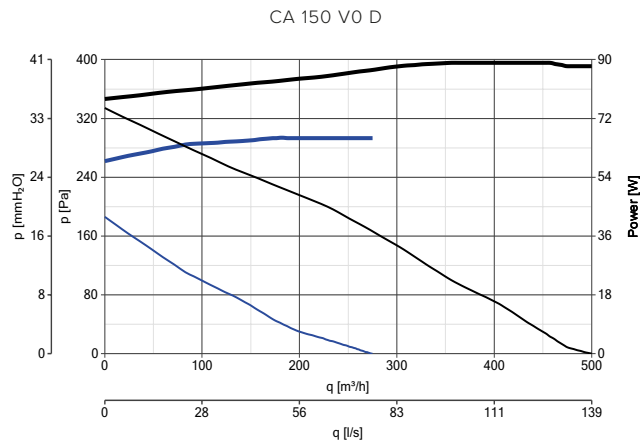
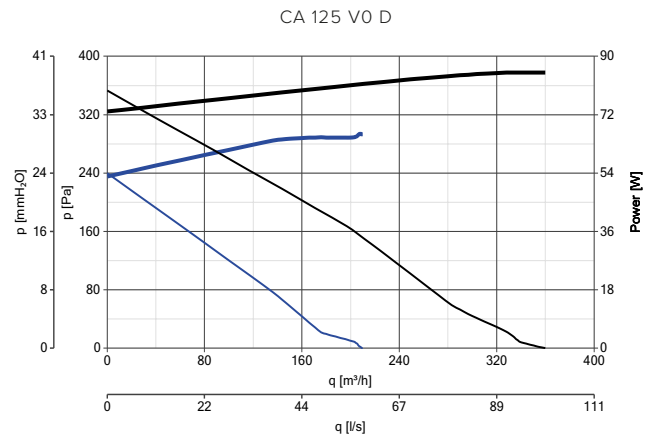
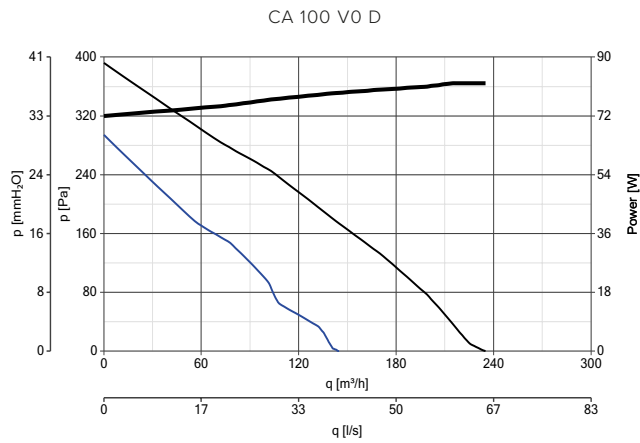





**AVAILABLE ONLY FOR EXTRA EU MARKET**







## CONTROLLERS

MODELS	DESCRIPTION	CODE	PRODUCT
	<b>C 1.5</b> - ELECTRONIC SPEED CONTROLLER 1.5 A	12966	ALL PRODUCTS
	<b>C 2.5</b> - ELECTRONIC SPEED CONTROLLER 2.5 A	12967	ALL PRODUCTS
	<b>SCNRB</b> - BUILT-IN ELECTRONIC SPEED CONTROLLER	12971	ALL PRODUCTS
	<b>TRIO</b> - 3 SPEED SWITCH FOR WALL AND FLUSH MOUNTING INSIDE UNI 503 STANDARD ELECTRIC BOXES	12869	16008 - 16018 - 16028 - 16035 - 16038 - 16039 - 16041
	<b>KIT SCB</b> - BUILT-IN CONTROLLER ADAPTOR	22481	12966 - 12967
	<b>IREM D</b> - ELECTRONIC SPEED CONTROLLER FOR INSTALLATION IN STANDARD DIN BOX. MAXIMUM LOAD: 1.0 A.	12867	ALL PRODUCTS
	<b>DUO</b> - 2 SPEEDS CONTROLLER	22914	16034 - 16044 - 16054 - 16064
	<b>IRM5 2B</b> - 5-POSITION SPEED CONTROLLER OF THE AUTOTRANSFORMER TYPE, DESIGNED TO CONTROL SINGLE-PHASE ASYNCHRONOUS MOTORS.	12861	16090
	<b>C TEMP</b> - THERMO SWITCH	12992	ALL PRODUCTS
	<b>C SMOKE</b> - AIR QUALITY SENSOR	12993	ALL PRODUCTS
	<b>C HCS</b> - HUMIDISTAT	12994	ALL PRODUCTS
	<b>C PIR</b> - PASSIVE INFRARED SENSOR	12998	ALL PRODUCTS
	<b>C TIMER</b> - TIMER	12999	ALL PRODUCTS

## ACCESSORIES ON REQUEST

MODELS	DESCRIPTION	CODE	PRODUCT
	<b>CA-MU</b> - MOUNTING BRACKETS	22674	ALL PRODUCTS
		100	22750
		125	22755
		150	22760
	<b>CA-G</b> - PROTECTION GRILLE	200	22765
		250	22770
		315	22775
			16008
			16018
			16028
			16035 - 16038
			16039
			16041 - 16090

**CA MD RANGE**  
IN-LINE CENTRIFUGAL FANS IN METAL

## CA MD RANGE

In-line centrifugal fans in metal

Painted sheet steel mixed flow duct fans, installed in false ceilings or in attics. The ideal low-visual impact ventilation solution for residential, commercial or industrial premises (kitchens, toilets, laboratories, bars, restaurants, laundries, shops, etc).

### VERSIONS

8 models, with nominal diameter between 100 and 315 mm.

### KEY FEATURES

- Built to withstand weathering and high temperatures.
- Standard supplied support brackets.
- High protection rating from dust and water for safe use in industrial environments.
- Wide continuous operation temperature range (-25 °C / + 50 °C).
- Can be installed horizontally, vertically or sloping.

### TECHNICAL FEATURES

- Pickled, phosphate-coated steel sheet casing that has been painted with polyester paint against aggressive weathering.
- Motor-holder built into the boxes housing the mains connection terminals and the flow conditioner fins, constructed in self-extinguishing plastic resin (V0).
- 3-speed fans that can be set using optional device TRIO-CA (code 12869), composed of:
  - AC motors with thermal overload cut-out and shafts turning on ball bearings to guarantee long lasting continuous service (at least 30,000 h) at the maximum plate temperature.
  - Backward-curve, heat resistant plastic resin blade impellers loaded with glass fibre to combine structural strength and dimensional stability.
- Galvanised steel sheet brackets for wall, ceiling and false ceiling installation.
- Possibility of connecting to remote environmental temperature, humidity, smoke and presence sensors (optional).
- Performance and safety certified by third party body (IMQ).
- Protection rating from dusts and water: IP44 (appliance ducted in extraction and delivery).
- Insulation Class: II .

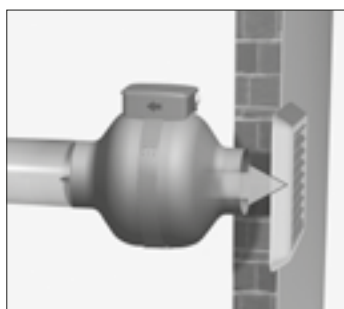





## TECHNICAL DATA

Models	Code	V~50HZ	Max Airflow					Max Pressure		LP DB(A) 3m	Max °C	KG
			W	A	RPM	m³/h		mmH₂O	Pa			
						min/med/max	min/med/max					
CA 100 MD	16150	230	26 47 85	0,22 0,30 0,40	1190 1810 2370	163 250 337	45,0 69,4 93,0	19,9 33 38,9	195,9 323,4 381,6	32,3* - 43,2*	50	2,97
CA 125 MD	16151	230	26 47 85	0,22 0,30 0,40	1130 1685 2300	210 315 445	58,0 87,5 123,6	17,6 30,7 36,8	172,6 301,3 361,4	30,8* - 45,9*	50	3,0
CA 150 MD E	16163	230	26 47 85	0,22 0,30 0,38	1160 1725 2650	230 350 535	63,8 97,2 148,6	12,3 25,3 44,3	121,0 248,7 435,1	42,3** - 53,2**	50	4,9
CA 150 Q MD	16152	230	26 47 85	0,22 0,30 0,40	1160 1725 2340	230 350 470	63,8 97,2 130,5	12,3 25,3 33,3	121,1 248,2 327,0	34,7* - 48,1*	50	2,98
CA 160 MD E	16164	230	39 53 85	0,35 0,36 0,38	1130 2160 2665	325 450 555	90,2 125 154,1	32,7 41,8 44,0	321,5 409,8 431,8	43,4* - 53,4*	50	4,9
CA 200 MD E	16165	230	39 57 89	0,35 0,38 0,43	1440 2140 2630	412 620 775	114,0 172,2 215,0	36,0 45,0 45,0	353,0 441,0 441,0	36,2** - 48,1**	50	4,8
CA 250 MD E	16166	230	50 82 120	0,47 0,55 0,53	1410 2120 2635	540 805 1010	150,0 223,6 280,5	33,7 49,2 54,8	330,8 482,6 537,6	38,3** - 52,7**	50	5,3
CA 315 MD E	16167	230	50 82 120	0,47 0,54 0,53	1510 2150 2630	570 830 1015	158,3 230,5 281,9	36,0 50,7 55,5	353,2 497,3 544,9	41,8** - 52,3**	50	7,0
<b>NEW</b> CA 315 MD SE	16097	220-240	190	0,84	2800	1550	430	67	657	58\	45	6.6

\* Sound pressure level measured at 3 m in free field conditions with long-cased appliance in delivery mode in accordance with standard EN ISO 3741.

\*\* Sound pressure level measured at 3 m in free field conditions with long-cased appliance in delivery mode in accordance with standard EN ISO 9614.

## CA MD RANGE

Available only for Extra EU market and therefore not in compliance with Reg. ErP 2018

- 8 models, with nominal diameter between 100 and 315 mm.
- 2-speed motors with thermal overload cut-out and shaft turning in ball bearings to guarantee long lasting continuous service (at least 30,000 h) at the maximum plate temperature. Speed adjustment using Vortice accessory devices.
- Performance and safety certified by third party body (IMQ).

## TECHNICAL DATA - AVAILABLE ONLY FOR EXTRA EU MARKET

Models	Code	V~50/60HZ	Max Airflow					Max Pressure		LP DB(A) 3m	Max °C	KG
			W min/max	A min/max	RPM min/max	m³/h min/max	l/s min/max	mmH₂O min/max	Pa min/max			
CA 100 MD*	16107	220-240	60 85	0.30 0.40	1730 2450	220 340	61 94	30 39	294 383	32.2** 43.2**	50	2.97
CA 125 MD*	16108	220-240	60 85	0.30 0.40	1580 2380	280 450	78 125	27 37	265 363	30.8** 45.9**	50	3.0
CA 150 MD*	16153	220-240	110 155	0.50 0.70	1815 2080	570 770	188 214	44 54	432 530	40.7 48.0	50	5.52
CA 150 Q MD*	16109	220-240	60 85	0.30 0.40	1430 2350	300 500	83 139	21 35	206 343	34.7** 48.1**	50	2.98
CA 160 M*	16154	220-240	110 155	0.55 0.70	1654 2080	640 840	178 228	41 50	402 491	40.7 47.4	50	5.47
CA 200 MD*	16155	220-240	110 155	0.55 0.70	1700 2100	820 1050	228 292	37 48	363 471	43.8 49.6	50	5.43
CA 250 MD*	16156	220-240	115 200	0.55 0.90	1800 2420	950 1300	264 361	42 56	412 549	46.7 55.9	50	6.55
CA 315 MD*	16157	220-240	190 280	0.85 1.25	1940 2500	1350 1800	375 500	52 72	510 706	52.4 57.7	50	9.47

\* Available only for the Extra EU market

\*\* Sound pressure level measured at 3 m in free field conditions with long-cased appliance in delivery mode in accordance with standard EN ISO 3741.

\*\*\* Sound pressure level measured at 3 m in free field conditions with long-cased appliance in delivery mode in accordance with standard EN ISO 9614.

**CA MD RANGE**  
IN-LINE CENTRIFUGAL FANS IN METAL

**ENERGY DATA FOR REGULATION N° 1254/2014/UE**

	<b>UNIT OF MEASURE</b>	<b>CA 160 MD E</b>	<b>CA 200 MD E</b>	<b>CA 250 MD E</b>	<b>CA 15 MD E</b>	<b>CA 315 MD SE</b>
<b>CODE</b>		16164	16165	16166	16167	16097
Supplier's name or trade mark	-	Vortice	Vortice	Vortice	Vortice	Vortice
SFPint	W(m³/s)	482,85	382,78	397,50	385,03	293,89
Declared typology	-	NRVU-U**	NRVU-U**	NRVU-U**	NRVU-U**	NRVU-U**
Type of drive	-	MSD***	MSD***	MSD***	MSD***	MSD***
Type of heat recovery system HRS	-	None	None	None	None	NONE
Nominal NRVU flow rate	m³/s	0,13611	0,21389	0,2747	0,2791	0,361
Effective electric power input	kW	0,088	0,089	0,127	0,123	0,220
Face velocity at design flow rate	m/s	6,7696	6,8083	5,5966	3,5822	4,633
Nominal external pressure (Δps, ext)	Pa	70	12	21	18	187
Internal pressure drop of ventilation components (Δps,int)	Pa	279	135	126	122	175
Internal pressure drop of non-ventilation components (Δps,add)	Pa	0	0	0	0	0
Static efficiency of fans used in accordance with Regulation (EU) N. 327/2011	%	43,2	35,3	31,8	31,8	40,2
Declared maximum internal leakage rate of the casing of ventilation units	%	NA*	NA*	NA*	NA*	NA*
Declared maximum external leakage rate of the casing of ventilation units	%	5,9	4,2	2,3	2,2	0,5
Energy performance or classification of the filters	-	NA*	NA*	NA*	NA*	NA*
Description of visual filter warning	-	NA*	NA*	NA*	NA*	NA*
Casing sound power level	LWA[dB(A)]	74	69	73	73	75

	<b>UNIT OF MEASURE</b>	<b>CA 100 MD</b>	<b>CA 125 MD</b>	<b>CA 150 MD E</b>	<b>CA 150 Q MD</b>
<b>CODE</b>		16150	16151	16163	16152
Supplier's name or trade mark	-	Vortice	Vortice	Vortice	Vortice
SFPint	W(m³/s)	602,29	478,53	567,30	408,13
Declared typology	-	NRVU-U**	NRVU-U**	NRVU-U**	NRVU-U**
Type of drive	-	MSD***	MSD***	MSD***	MSD***
Type of heat recovery system HRS	-	None	None	None	None
Nominal NRVU flow rate	m³/s	0,07917	0,09861	0,14333	0,10260
Effective electric power input	kW	0,051	0,051	0,086	0,053
Face velocity at design flow rate	m/s	10,08	8,0335	8,110	5,8003
Nominal external pressure (Δps, ext)	Pa	12,8	8,8	15	31,4
Internal pressure drop of ventilation components (Δps,int)	Pa	183	148	255	149
Internal pressure drop of non-ventilation components (Δps,add)	Pa	0	0	0	0
Static efficiency of fans used in accordance with Regulation (EU) N. 327/2011	%	30,4	30,7	44,9	28,8
Declared maximum internal leakage rate of the casing of ventilation units	%	NA*	NA*	NA*	NA*
Declared maximum external leakage rate of the casing of ventilation units	%	3,6	3,0	6,3	2,8
Energy performance or classification of the filters	-	NA*	NA*	NA*	NA*
Description of visual filter warning	-	NA*	NA*	NA*	NA*
Casing sound power level	LWA[dB(A)]	64	66	74	69

\*NA: Not applicable - \*\*RVU-U: Non Residential Ventilation Unit - Unidirectional - \*\*\*MSD: Multi-Speed Drive



**DIMENSIONS**

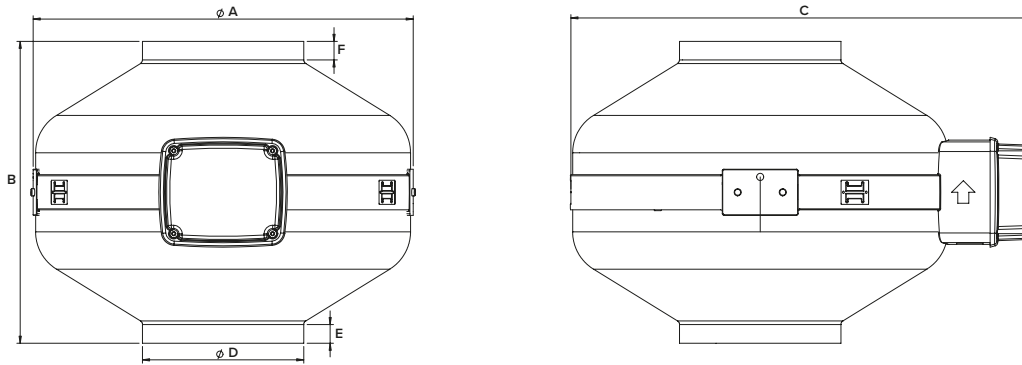

MODELS	ØA	B	C	ØD	E	F
CA 100	255	239	330	97	15	15
CA 125	255	239	330	122	23	23
CA 150 Q	255	239	330	147	30	30
CA 150	347	275	424	147	17	17
CA 160	347	275	424	157	18	18
CA 200	347	275	424	197	20	17
CA 250	347	275	424	247	38	35
CA 315	406	306	488	312	21	30
CA 315 SE	415	314	455	312	29	42

Dimensions (mm)

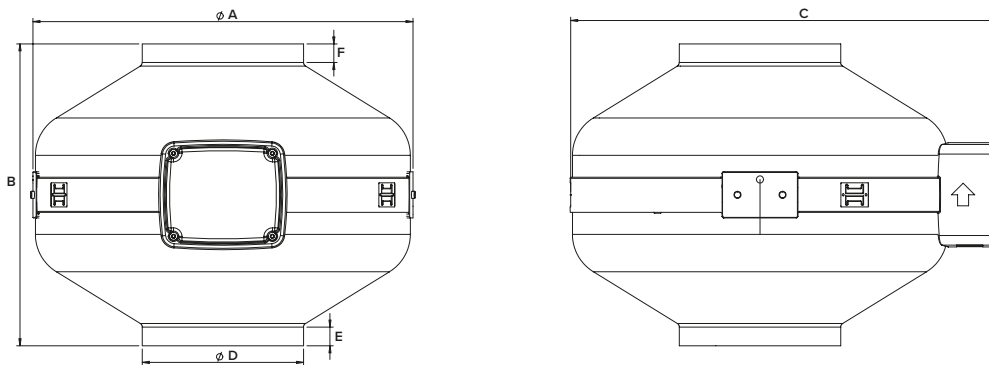

**AVAILABLE ONLY FOR EXTRA EU MARKET**

MODELS	ØA	B	C	ØD	E	F
CA 100	255	239	300	97	15	15
CA 125	255	239	300	122	23	23
CA 150 Q	255	239	300	147	30	30
CA 150	347	275	424	147	17	17
CA 160	347	375	424	157	18	18
CA 200	347	275	424	197	20	17
CA 250	347	375	394	247	38	35
CA 315	406	306	458	312	21	30

Dimensions (mm)

**CA MD RANGE**  
IN-LINE CENTRIFUGAL FANS IN METAL

**PERFORMANCE CURVES**

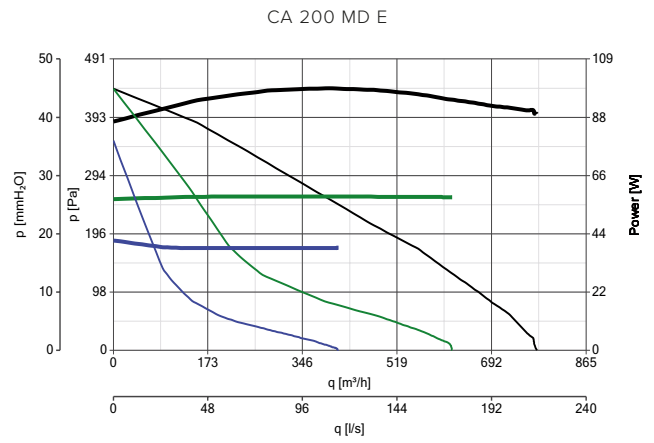
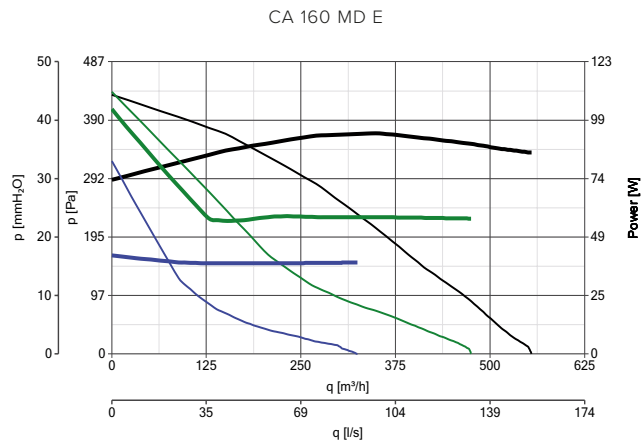
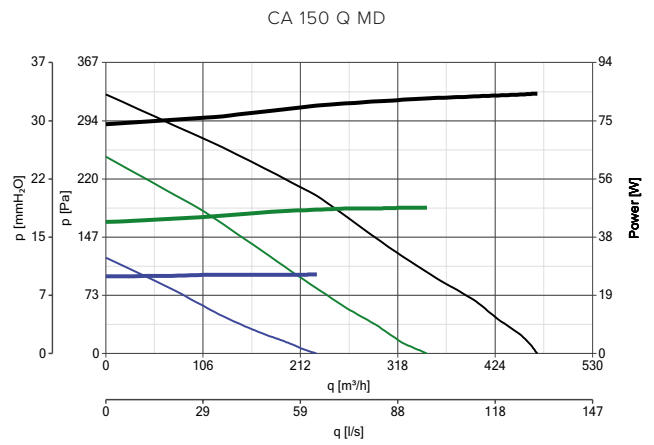
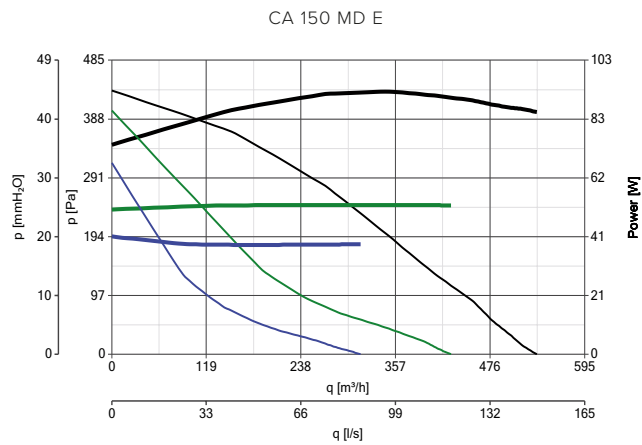
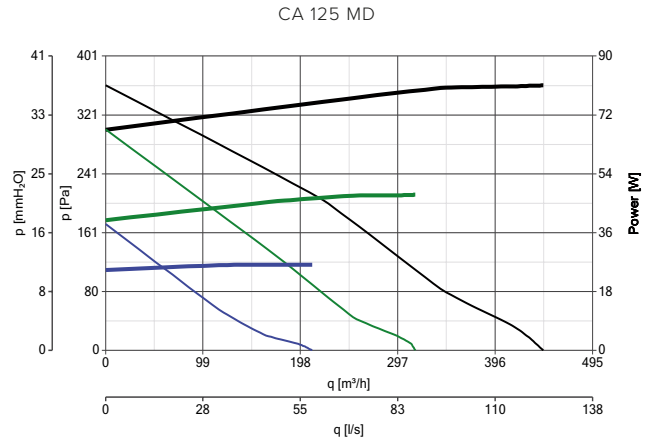
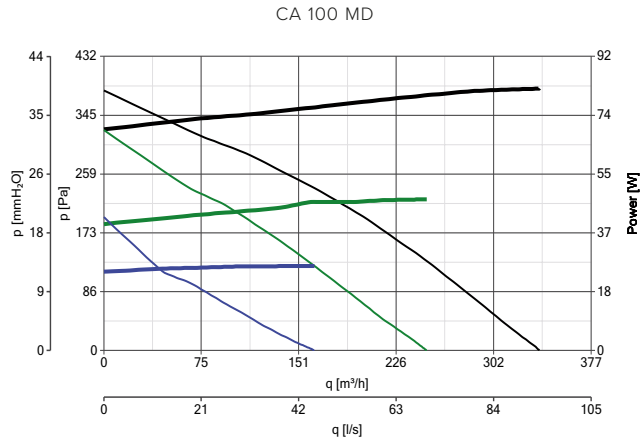

<b>POWER CONSUMPTION</b>	<b>PERFORMANCE CURVES</b>
— max	— max
— med	— med
— min	— min





### PERFORMANCE CURVES

CA 250 MD E

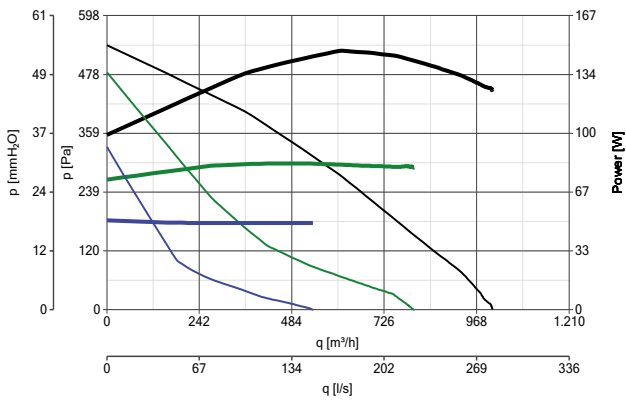

CA 315 MD E

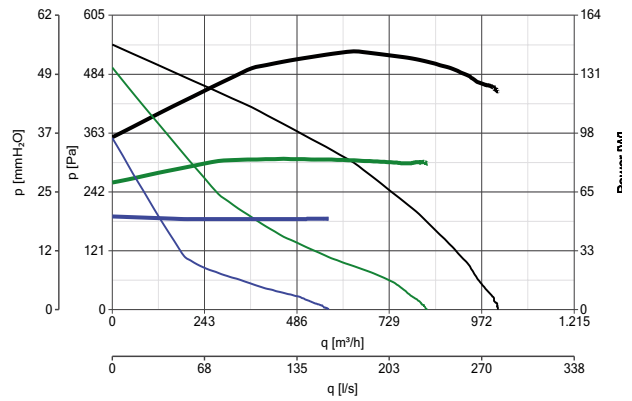

CA 315 MD SE

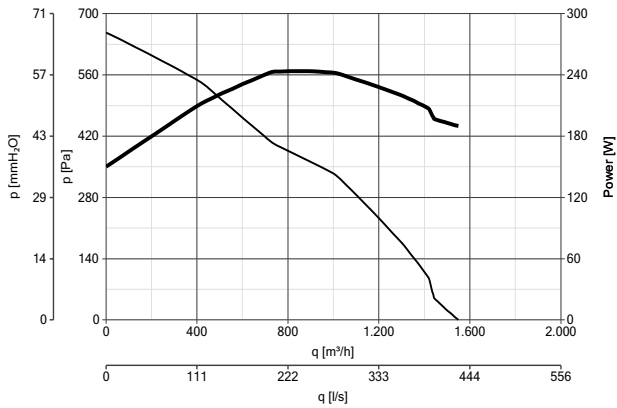

POWER CONSUMPTION      PERFORMANCE CURVES  
 — max                      — max  
 — med                     — med  
 — min                      — min



**CA MD RANGE**  
IN-LINE CENTRIFUGAL FANS IN METAL

AVAILABLE ONLY FOR EXTRA EU MARKET

CA 100 MD\*

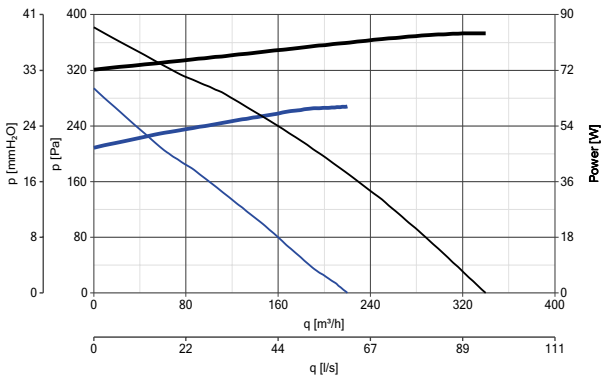

CA 125 MD\*

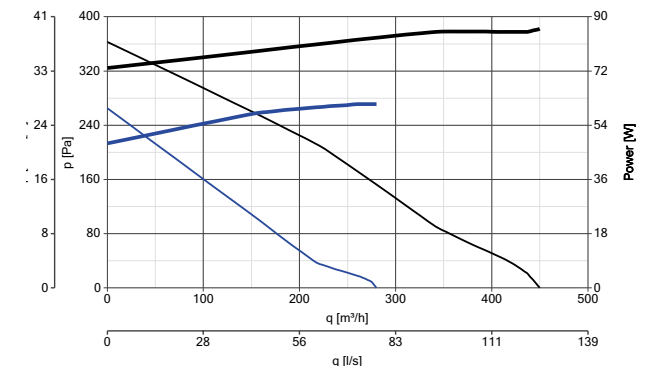

CA 150 MD\*

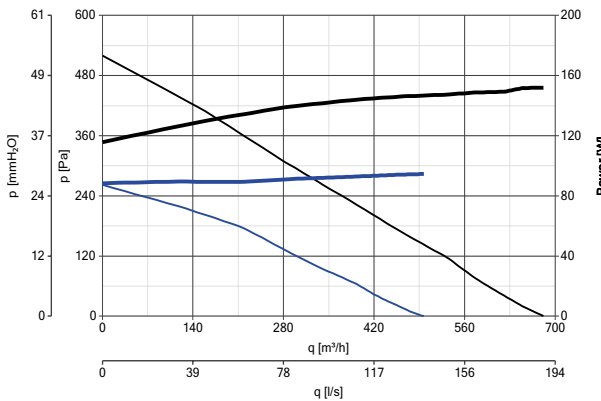

CA 150 Q MD\*

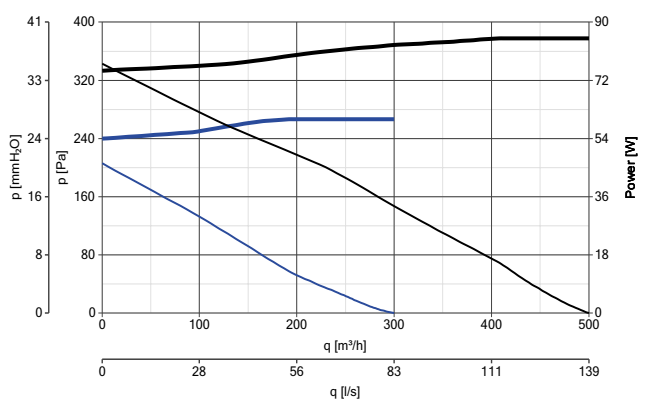

\* Available only for Extra EU markets

CA 160 MD

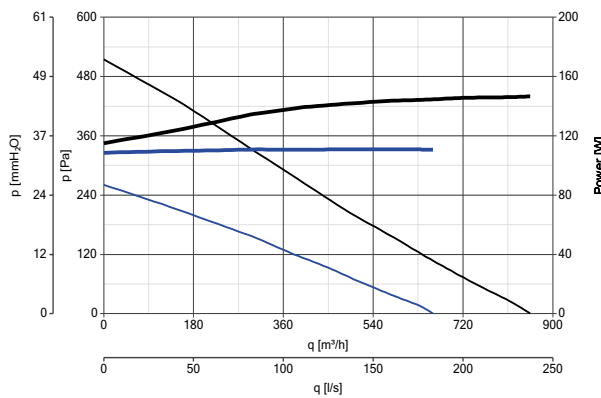

CA 200 MD

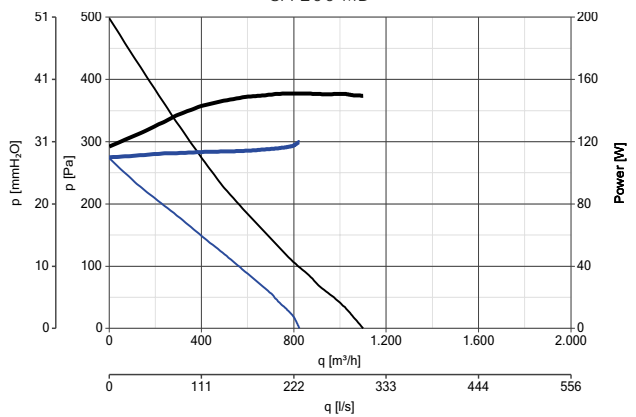

POWER CONSUMPTION      PERFORMANCE CURVES  
 — max                      — max  
 — min                      — min







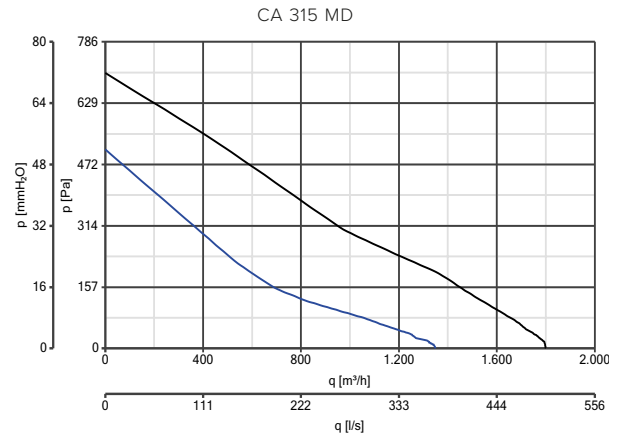
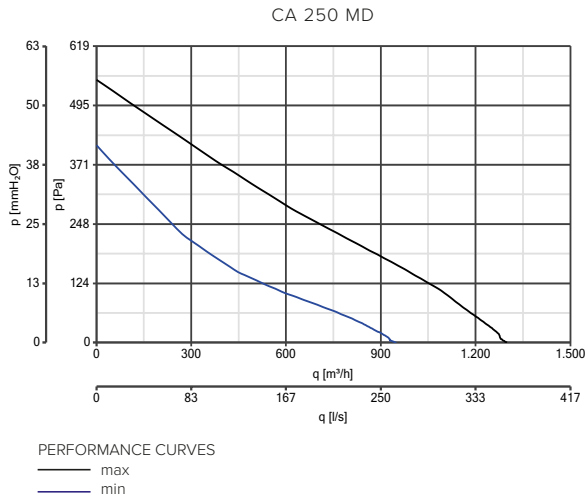



AVAILABLE ONLY FOR EXTRA EU MARKET



CONTROLLERS

MODELS	DESCRIPTION	CODE	PRODUCT
	<b>C 1.5</b> - ELECTRONIC SPEED CONTROLLER 1.5 A	12966	ALL PRODUCTS
	<b>C 2.5</b> - ELECTRONIC SPEED CONTROLLER 2.5 A	12967	ALL PRODUCTS
	<b>SCNRB</b> - ELECTRONIC SPEED CONTROLLER. BUILT-IN	12971	ALL PRODUCTS
	<b>KIT SCB</b> - BUILT-IN CONTROLLER ADAPTOR	22481	12966 - 12967
	<b>TRIO</b> - 3 SPEED SWITCH FOR WALL AND FLUSH MOUNTING INSIDE UNI 503 STANDARD ELECTRIC BOXES	12869	16150 - 16151 - 16163 - 16152 - 16164 16165 - 16166 - 16167
	<b>IRM5 2B</b> - 5-POSITION SPEED CONTROLLER OF THE AUTOTRANSFORMER TYPE, DESIGNED TO CONTROL SINGLE-PHASE ASYNCHRONOUS MOTORS.	12861	16097

ACCESSORIES ON REQUEST

MODELS	DESCRIPTION	CODE	PRODUCT
	<b>CA-MU</b> - MOUNTING BRACKETS	22674	ALL PRODUCTS
		100	22750
		125	22755
		150	22760
		200	22765
		250	22770
		315	22775
	<b>CA-G</b> - PROTECTION GRILLE		16150 - 16107 16151 - 16108 16152 - 16163 - 16109 - 16153 16165 - 16155 16166 - 16156 16167 - 16157 - 16097



## **CA ES RANGE**

"Energy Saving" in-line centrifugal fans in metal

Painted sheet steel mixed flow duct fans equipped with 2-speed brushless motors. Installed in false ceilings or attics, ensuring the proper ventilation of residential, commercial or industrial premises (kitchens, toilets, laboratories, bars, restaurants, laundries, shops, etc.), combining their low-visual impact with especially low consumption.

### **VERSIONS**

8 models, with nominal diameter between 100 and 315 mm.

### **KEY FEATURES**

- High efficiency EC (brushless) motors that are continuously adjustable (0-10V signal) or are settable at installation for 2-speed operation that can be set as needed.
- Built to withstand weathering and high temperatures.
- Standard supplied support brackets.
- High protection rating from dust and water for safe use in industrial environments.
- Wide continuous operation temperature range (-25 °C / + 50 °C).
- Can be installed horizontally, vertically or sloping.

### **TECHNICAL FEATURES**

- Pickled, phosphate-coated steel sheet casing that has been painted with polyester paint against aggressive weathering.
- Motor-holder built into the boxes containing motor drivers and the flow conditioner fins, constructed in self-extinguishing plastic resin (V0).
- Two-speed EC (brushless) motors with thermal overload cut-out and shafts turning on ball bearings to guarantee long lasting (at least 40,000 h) continuous service at the maximum plate temperature. Possibility of continuous speed adjustment through potentiometers (0-10V signal).
- Backward-curve, heat resistant plastic resin blade impellers loaded with glass fibre to combine structural strength and dimensional stability.
- Galvanised steel sheet brackets for wall, ceiling and false ceiling installation.
- Possibility of connecting to remote environmental temperature, humidity, smoke and presence sensors (optional).
- Protection rating from dusts and water: IP44 (appliance ducted in extraction and delivery).
- Insulation Class: II .

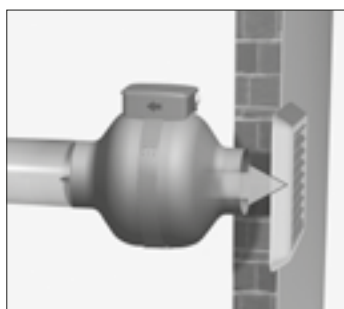





## TECHNICAL DATA

Models	Code	V-50	W min/max	A min/max	RPM min/max	Max Airflow		Max Pressure		LP DB(A) 3m* max	Max °C	KG
						m <sup>3</sup> /h min/max	l/s min/max	mmH <sub>2</sub> O min/max	Pa min/max			
CA 100 ES	16200	220-240	3 80	0,05 0,7	300 2720	33 385	9 107	0,5 52	5 510	46,9	50	2,7
CA 125 ES	16201	220-240	3 80	0,05 0,7	300 2650	52 520	14 144	0,5 47	5 461	49,7	50	2,6
CA 150 ES	16203	220-240	3 120	0,05 1,0	300 2250	100 800	28 222	0,7 100	7 490	48,1	50	4,5
CA 150 Q ES	16202	220-240	3 80	0,05 0,7	300 2670	56 560	16 156	5 45	5 441	49,6	50	2,6
CA 160 ES	16204	220-240	3 120	0,05 1	300 2240	110 900	31 250	0,7 50	7 490	48,1	50	4,6
CA 200 ES	16205	220-240	3 120	0,05 1	300 2280	125 1140	35 317	0,7 50	7 490	47,6	50	4,6
CA 250 ES	16206	220-240	4,5 140	0,05 1,1	300 2500	130 1300	36 361	0,7 60	7 588	40,1	50	4,9
CA 315 ES	16207	220-240	4,5 160	0,05 1,3	300 2380	170 1600	47 444	0,8 62	8 608	39,7	50	6,9

\* Sound pressure level measured at 3 m in free field conditions with long-cased appliance in delivery mode in accordance with standard EN ISO 9614.

## ENERGY DATA FOR REGULATION N° 1254/2014/UE

	UNIT OF MEASURE	CA 100 ES	CA 125 ES	CA 150 ES	CA 150 Q ES
CODE		16200	16201	16203	16202
Supplier's name or trade mark	-	Vortice	Vortice	Vortice	Vortice
SFPint	W(m <sup>3</sup> /s)	437,72	184,03	211,41	2121,69
Declared typology	-	NRVU-U**	NRVU-U**	NRVU-U**	NRVU-U**
Type of drive	-	MSD***	MSD***	MSD***	MSD***
Type of heat recovery system HRS	-	None	None	None	None
Nominal NRVU flow rate	m <sup>3</sup> /s	0,079	0,078	0,138	0,078
Effective electric power input	kW	0,08	0,078	0,12	0,084
Face velocity at design flow rate	m/s	10,044	6,338	7,797	4,401
Nominal external pressure (Δps, ext)	Pa	162	235	197	233
Internal pressure drop of ventilation components (Δps,int)	Pa	123	53	63	57
Internal pressure drop of non-ventilation components (Δps,add)	Pa	0	0	0	0
Static efficiency of fans used in accordance with Regulation (EU) N. 327/2011	%	28,1	28,8	29,8	26,8
Declared maximum internal leakage rate of the casing of ventilation units	%	NA*	NA*	NA*	NA*
Declared maximum external leakage rate of the casing of ventilation units	%	2,3	2,4	3,9	2,4
Energy performance or classification of the filters	-	NA*	NA*	NA*	NA*
Description of visual filter warning	-	NA*	NA*	NA*	NA*
Casing sound power level	LWA[dB(A)]	NA*	NA*	NA*	NA*

\*NA: Not applicable - \*\*RVU-U: Non Residential Ventilation Unit - Unidirectional - \*\*\*MSD: Multi-Speed Drive

**CA ES RANGE**  
"ENERGY SAVING" IN-LINE CENTRIFUGAL FANS IN METAL

**ENERGY DATA FOR REGULATION N° 1254/2014/UE**

	UNIT OF MEASURE	CA 160 ES	CA 200 ES	CA 250 ES	CA 315 ES
CODE		16204	16205	16206	16207
Supplier's name or trade mark	-	Vortice	Vortice	Vortice	Vortice
SFPint	W(m³/s)	145,21	51,37	35,61	24,32
Declared typology	-	NRVU-U**	NRVU-U**	NRVU-U**	NRVU-U**
Type of drive	-	MSD***	MSD***	MSD***	MSD***
Type of heat recovery system HRS	-	None	None	None	None
Nominal NRVU flow rate	m³/s	0,140	0,142	0,225	0,236
Effective electric power input	kW	0,119	0,123	0,144	0,172
Face velocity at design flow rate	m/s	6,963	4,518	4,578	3,023
Nominal external pressure ( $\Delta p_{s, ext}$ )	Pa	214	238	203	232
Internal pressure drop of ventilation components ( $\Delta p_{s, int}$ )	Pa	44	15	12	8
Internal pressure drop of non-ventilation components ( $\Delta p_{s, add}$ )	Pa	0	0	0	0
Static efficiency of fans used in accordance with Regulation (EU) N. 327/2011	%	30,3	29,2	33,7	32,9
Declared maximum internal leakage rate of the casing of ventilation units	%	NA*	NA*	NA*	NA*
Declared maximum external leakage rate of the casing of ventilation units	%	3,8	3,8	1,8	1,7
Energy performance or classification of the filters	-	NA*	NA*	NA*	NA*
Description of visual filter warning	-	NA*	NA*	NA*	NA*
Casing sound power level	LWA[dB(A)]	NA*	NA*	NA*	NA*

\*NA: Not applicable - \*\*RVU-U: Non Residential Ventilation Unit - Unidirectional - \*\*\*MSD: Multi-Speed Drive

**DIMENSIONS**

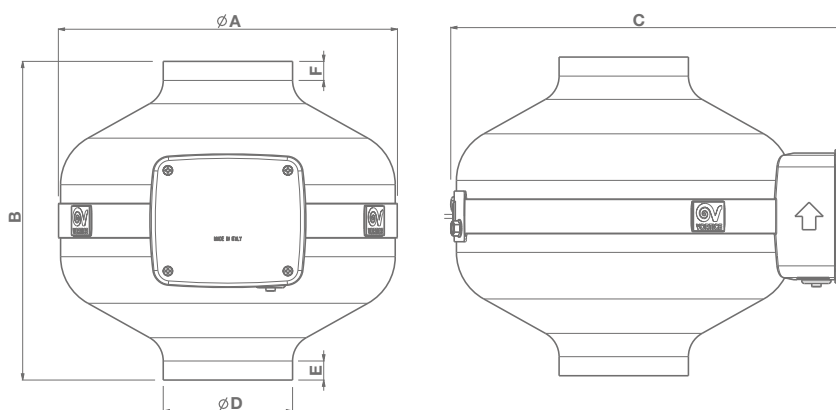

MODELS	ØA	B	C	ØD	E	F
CA 100 ES	255	239	330	97	15	15
CA 125 ES	255	239	330	122	23	23
CA 150 ES	347	275	422	147	17	17
CA 150 Q ES	255	239	330	147	30	30
CA 160 ES	347	275	422	157	18	18
CA 200 ES	347	275	422	197	20	17
CA 250 ES	347	267	392	247	30	35
CA 315 ES	406	362	455	315	35	30

Dimensions (mm)



PERFORMANCE CURVES

CA 100 ES

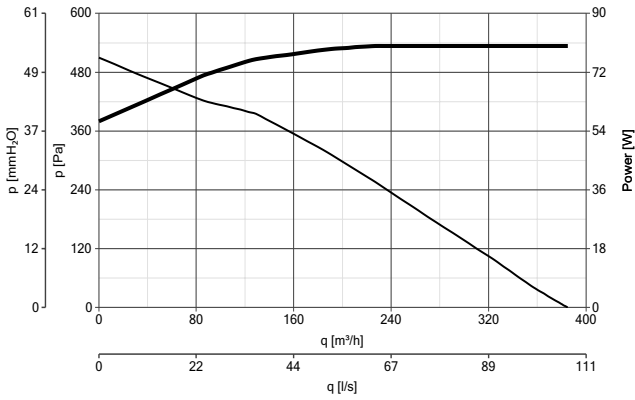

CA 125 ES

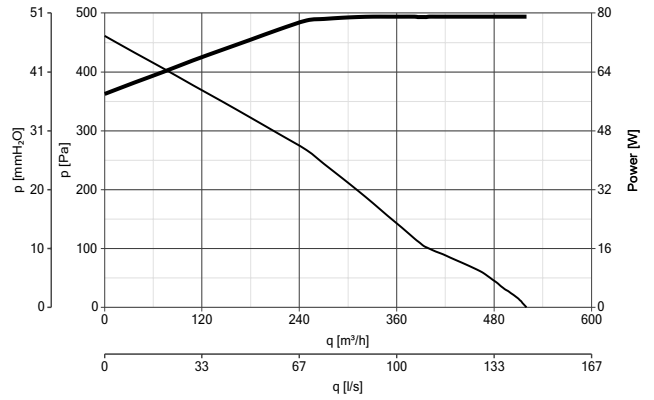

CA 150 ES

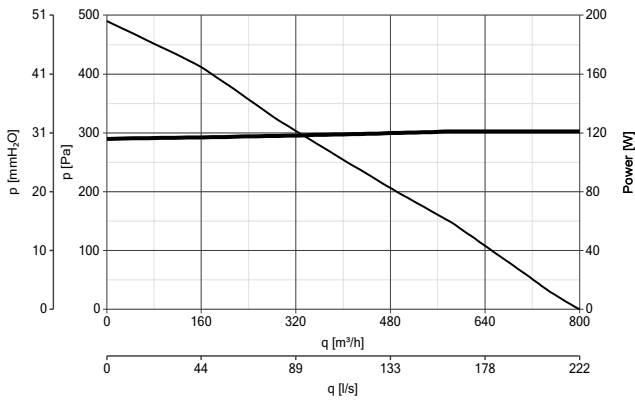

CA 150 Q ES

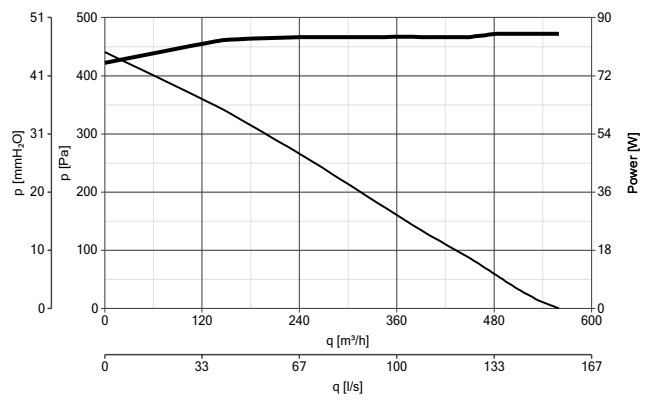

CA 160 ES

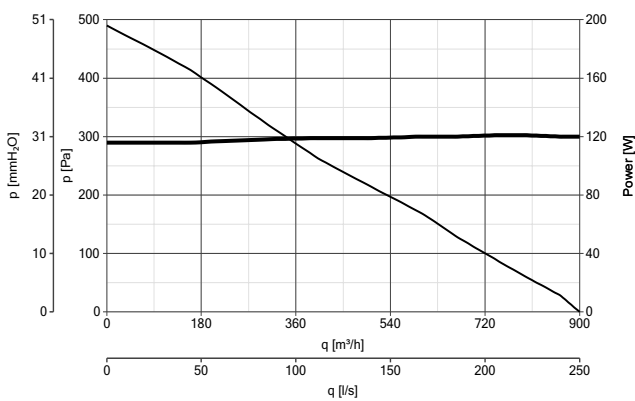

CA 200 ES

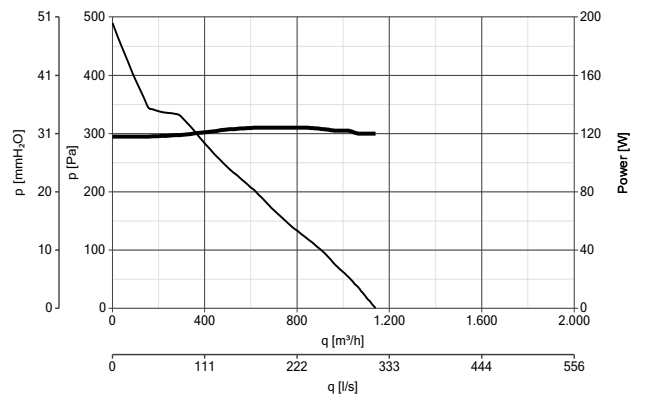

— Power consumption  
 — Performance curves





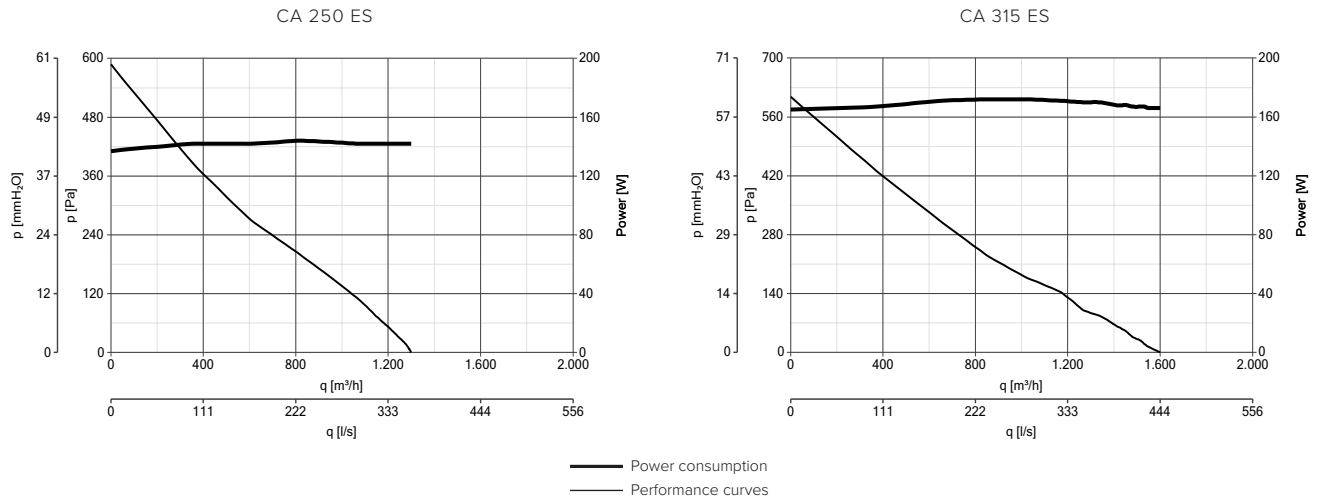

**CA ES RANGE**  
 "ENERGY SAVING" IN-LINE CENTRIFUGAL FANS IN METAL

**PERFORMANCE CURVES**







## CONTROLLERS

MODELS	DESCRIPTION	CODE	PRODUCT
	<b>POT-IT</b> - POTENTIOMETER	12826	ALL PRODUCTS
	<b>POT</b> - POTENTIOMETER	12828	ALL PRODUCTS
	<b>DUO</b> - 2 SPEEDS CONTROLLER	22914	ALL PRODUCTS
	<b>C TEMP</b> - THERMO SWITCH	12992	ALL PRODUCTS
	<b>C SMOKE</b> - AIR QUALITY SENSOR	12993	ALL PRODUCTS
	<b>C HCS</b> - HUMIDISTAT	12994	ALL PRODUCTS
	<b>C PIR</b> - PASSIVE INFRARED SENSOR	12998	ALL PRODUCTS
	<b>C TIMER</b> - TIMER	12999	ALL PRODUCTS

## ACCESSORIES ON REQUEST

MODELS	DESCRIPTION	CODE	PRODUCT
	<b>CA-MU</b> - MOUNTING BRACKETS	22674	ALL PRODUCTS
		100	22750 16200
		125	22755 16201
		150	22760 16202 - 16203
	<b>CA-G</b> - PROTECTION GRILLE	160	22762 16204
		200	22765 16205
		250	22770 16206
		315	22775 16207

## **CA WE D E RANGE**

Painted sheet steel mixed flow duct fans for external wall

Painted sheet steel mixed flow duct fans, designed for outdoor installation. The ideal low-visual impact, low-noise ventilation solution for residential or commercial premises (kitchens, toilets, laboratories, bars, restaurants, laundries, shops, etc.).

### **VERSIONS**

6 models, with nominal diameter between 100 and 200 mm.

### **KEY FEATURES**

- Built to withstand weathering and high temperatures.
- Designed to minimise noise in the environment.
- Automatic delivery closing to prevent air re-entry and the entry of foreign bodies.
- Fully compliant with Reg. ErP 2018 N. 1253/2014.

### **TECHNICAL FEATURES**

- Steel sheet front covers that have been painted with polyester paint against aggressive weathering. Grille-protected delivery spigots with automatic spring closure device to prevent the entry of foreign bodies.
- Rear flanges in plastic resin with a mineral-based additive to dampen vibrations and soften noise.
- 3-speed fans that can be set using optional device TRIO-CA (code 12869), composed of:
  - AC motors with thermal overload cut-out and shafts turning on ball bearings to guarantee long lasting (at least 40,000 h) continuous service at the maximum plate temperature.
  - Backward-curve, heat resistant plastic resin blade impellers loaded with glass fibre to combine structural strength and dimensional stability.
- Possibility of connecting to remote environmental temperature, humidity, smoke and presence sensors (optional).
- Performance and safety certified by third party body (IMQ).
- Protection rating from the water: IPX5.
- Insulation Class: II .





## TECHNICAL DATA

Models	Code	V~50	Max Airflow					Max Pressure		LP DB(A) 3m	Max °C	KG
			W min/med/max	A min/med/max	RPM min/med/max	m³/h min/med/max	l/s min/med/max	mmH <sub>2</sub> O min/med/max	Pa min/med/max			
CA 100 WED	16091	220-240	12 24 50	0,13 0,18 0,23	925 1515 2390	68 150 252	18,8 41,6 70	18,3 37,4 38,6	180 366,4 379,4	38,3 - 50,1	60	4,5
CA 125 WED	16092	220-240	12 24 50	0,13 0,18 0,23	880 1400 2350	85 175 328	23,6 48,6 91,1	15,3 34,3 36,7	150,4 336,3 359,5	36,3 - 49,5	60	4,5
CA 150 Q WED	16093	220-240	12 57 50	0,13 0,18 0,23	870 1410 2345	95 190 350	26,3 52,7 97,2	12,4 33,0 36,7	121,6 324 360	37,1 - 49,5	60	4,5
CA 150 WEDE	16087	230	38 100	0,36 0,44 0,44	1015 1455 2520	215 335 625	59,7 93 173,1	27,2 42,1 45,5	267,1 413,6 446,6	23,1 - 42,9	55	8
CA 160 WEDE	16088	230	38 57 100	0,36 0,44 0,44	1060 1475 2490	235 362 660	65,2 100,5 183,3	30,1 43,4 45,2	295,7 425,8 443,9	22 - 37,5	55	8
CA 200 WEDE	16089	230	38 53 100	0,36 0,44 0,44	1100 1460 2495	245 353 680	60 90 188,8	24,9 38,9 44,3	244,4 381,7 434,3	20,9 - 39,1	55	8

\* Sound pressure level measured at 3 m in free field conditions with long-cased appliance in delivery mode in accordance with standard EN ISO 9614.

## ENERGY DATA FOR REGULATION N° 1254/2014/UE

	UNIT OF MEASURE	CA 100 WED	CA 125 WED	CA 150 Q WED	CA 150 WEDE	CA 160 WEDE	CA 200 WEDE
CODE		16091	16092	16093	16087	16088	16089
Supplier's name or trade mark	-	Vortice	Vortice	Vortice	Vortice	Vortice	Vortice
SFPint	W(m³/s)	NA*	NA*	NA*	NA*	NA*	NA*
Declared typology	-	NRVU-U**	NRVU-U**	NRVU-U**	NRVU-U**	NRVU-U**	NRVU-U**
Type of drive	-	MSD***	MSD***	MSD***	MSD***	MSD***	MSD***
Type of heat recovery system HRS	-	None	None	None	None	None	None
Nominal NRVU flow rate	m³/s	0,06328	0,08097	0,09533	0,17219	0,18325	0,18492
Effective electric power input	kW	0,052	0,053	0,053	0,104	0,105	0,103
Face velocity at design flow rate	m/s	8,05678	6,59821	5,39476	9,74421	9,11411	5,88608
Nominal external pressure (Δps, ext)	Pa	471	314	20	69	20	98
Internal pressure drop of ventilation components (Δps,int)	Pa	-234	-121	144	157	187	107
Internal pressure drop of non-ventilation components (Δps,add)	Pa	0	0	0	0	0	0
Static efficiency of fans used in accordance with Regulation (EU) N. 327/2011	%	28,8	29,5	29,5	37,4	36,1	36,8
Declared maximum internal leakage rate of the casing of ventilation units	%	NA*	NA*	NA*	NA*	NA*	NA*
Declared maximum external leakage rate of the casing of ventilation units	%	NA*	NA*	NA*	NA*	NA*	NA*
Energy performance or classification of the filters	-	NA*	NA*	NA*	NA*	NA*	NA*
Description of visual filter warning	-	NA*	NA*	NA*	NA*	NA*	NA*
Casing sound power level	LWA[dB(A)]	50	50	50	43	38	39

\*NA: Not applicable - \*\*RVU-U: Non Residential Ventilation Unit - Unidirectional - \*\*\*MSD: Multi-Speed Drive

**CA WE D RANGE**  
PAINTED SHEET STEEL MIXED FLOW DUCT FANS FOR EXTERNAL WALL

**DIMENSIONS**

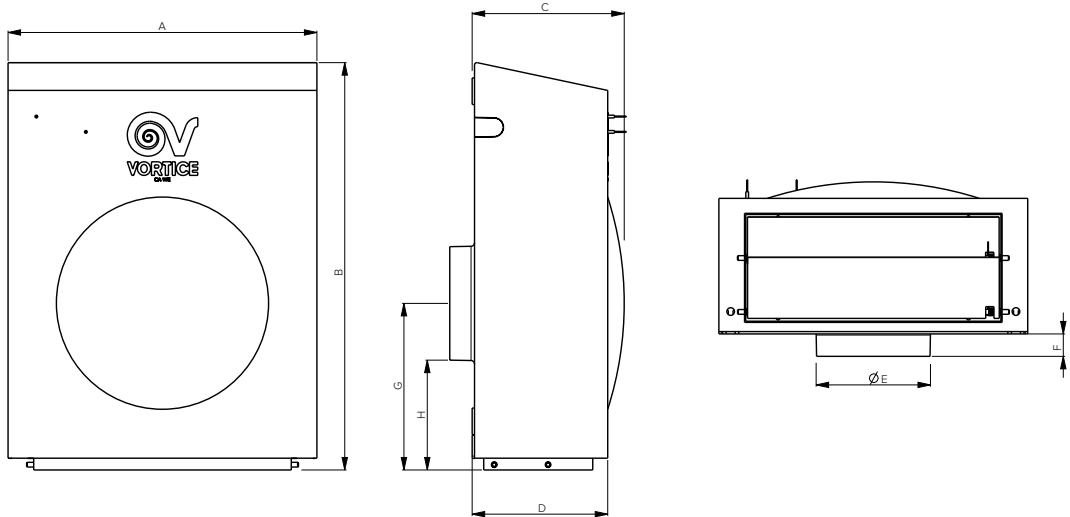

MODELS	A	B	C	D	ØE	F	G	H
CA 100 WE D	262	345	127	113	97	20	142	93
CA 125 WE D	262	345	127	113	122	20	142	80,5
CA 150 Q WE D	262	345	127	113	147	20	142	68
CA 150 WE DE	360	430	173	155	147	20	180	106
CA 160 WE DE	360	430	173	155	157	20	180	101
CA 200 WE DE	360	430	173	155	157	20	180	81

Dimensions (mm)

**PERFORMANCE CURVES**

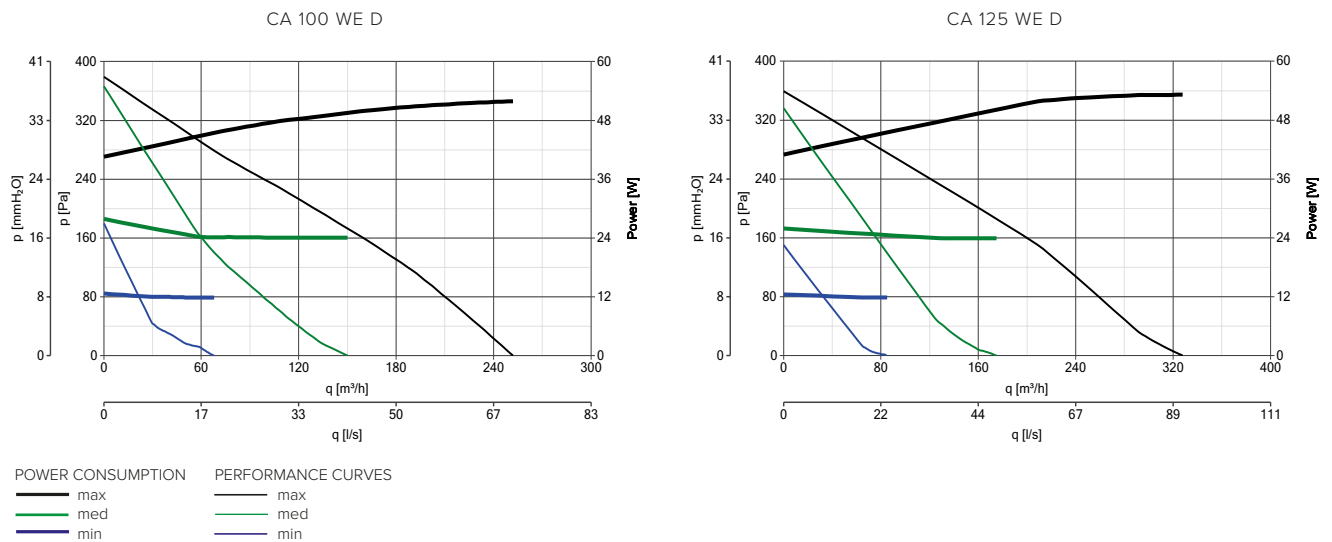





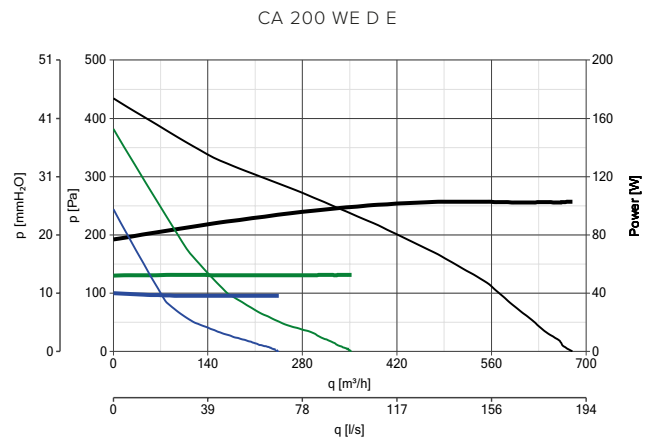
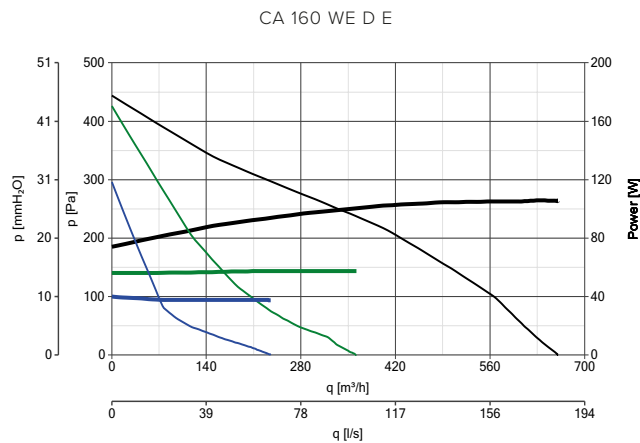
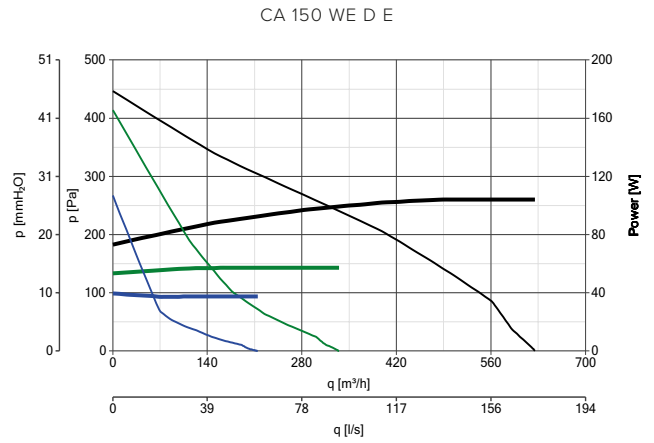
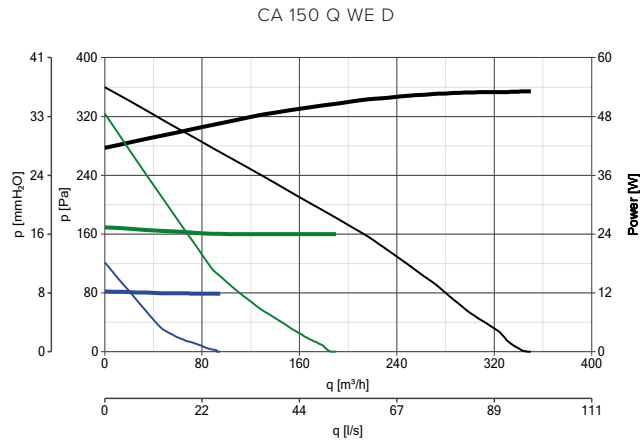

### PERFORMANCE CURVES



POWER CONSUMPTION      PERFORMANCE CURVES  
 — max                      — max  
 — med                     — med  
 — min                      — min

### CONTROLLERS

MODELS	DESCRIPTION	CODE	PRODUCT
	<b>C 1.5</b> - ELECTRONIC SPEED CONTROLLER 1.5 A	12966	ALL PRODUCTS
	<b>C 2.5</b> - ELECTRONIC SPEED CONTROLLER 2.5 A	12967	ALL PRODUCTS
	<b>KIT SCB</b> - BUILT-IN CONTROLLER ADAPTOR	22481	12966 - 12967
	<b>TRIO</b> - 3 SPEED SWITCH FOR WALL AND FLUSH MOUNTING INSIDE UNI 503 STANDARD ELECTRIC BOXES	12869	ALL PRODUCTS

## **CA MD E W RANGE**

Steel sheet mixed flow wall fans

Steel sheet mixed flow wall fans. Installed at the end of the ventilation duct, effectively meet the ventilation needs of commercial or industrial premises (laboratories, bars, restaurants, laundries, gyms, etc.).

### **VERSIONS**

8 models, with nominal diameter between 100 and 315 mm.

### **KEY FEATURES**

- Built to withstand weathering and high temperatures.
- Extremely reliable and low maintenance.
- Wide continuous operation temperature range.
- Fully compliant with Reg. ErP 2018 N. 1253/2014.

### **TECHNICAL FEATURES**

- Pickled, phosphate-coated steel sheet casing and wall fixing plates that have been painted with polyester paint against aggressive weathering.
- Motor-holder built into the boxes housing the mains connection terminals and the flow conditioner fins, constructed in self-extinguishing plastic resin (V0).
- 3-speed fans that can be set using optional device TRIO-CA (code 12869), composed of:
  - AC motors with thermal overload cut-out and shafts turning on ball bearings to guarantee long lasting continuous service (at least 30,000 h) at the maximum plate temperature.
  - Backward-curve, heat resistant plastic resin blade impellers loaded with glass fibre to combine structural strength and dimensional stability.
- Possibility of connecting to remote environmental temperature, humidity, smoke and presence sensors (optional).
- Performance and safety certified by third party body (IMQ).
- Protection rating from the water: IP44 (appliance ducted in extraction and delivery).
- Insulation Class: II .



## TECHNICAL DATA

Models	Code	V~50/60				Max Airflow		Max Pressure		LP DB(A) 3m*	Max °C	KG
			W	A	RPM	m³/h	l/s	mmH <sub>2</sub> O	Pa			
			min/med/max	min/med/max	min/med/max	min/med/max	min/med/max	min/med/max	min/med/max	min/med/max		
CA100 MDEW	16120	220-240	25 24 85	0,13 0,18 0,23	970 1650 2450	160 262 400	44,4 72,7 111,1	26,8 38,8 38,8	262,2 380,1 380,1	19,2 - 35,7	50	3,7
CA125 MDEW	16121	220-240	25 24 85	0,13 0,18 0,23	935 1660 2445	160 295 445	44,4 81,9 123,6	13,9 34,5 36,2	136,5 338,0 355,9	25,5 - 39,4	50	3,8
CA150 Q MDEW	16122	220-240	25 24 85	0,13 0,18 0,23	965 1615 2435	168 295 455	46,6 81,9 126,3	7,1 21 32,5	69,5 206,0 318,7	28,3 - 38	50	4,8
CA 150 MD E W	16133	220-240	39 50 85	0,34 0,35 0,38	1740 2230 2690	400 510 617	111,1 141,6 171,3	31,6 40,0 43,8	310,4 392,6 429,7	41,4 - 53,3	55	4,8
CA 160 MD E W	16134	220-240	38 50 85	0,35 0,35 0,38	1570 2120 2680	385,8 515 665	107,1 143 184,7	28 37,8 42,4	275,1 370,8 416,7	43 - 53	55	6,2
CA 200 MD E W	16135	220-240	39 50 90	0,35 0,35 0,40	1455 1960 2630	455 635 825	126,3 176,3 229,1	34,3 42,2 44	337,1 413,6 432,3	37,9 - 48,2	55	6
CA 250 MD E W	16136	220-240	48 79 130	0,48 0,57 0,55	1340 2015 2675	500 760 1030	138,8 211,1 286,1	34,9 52,8 55,9	342,3 518,4 548,3	31,6 - 50,8	50	6,2
CA 315 MD E W	16137	220-240	48 79 120	0,48 0,57 0,55	1335 2020 2670	490 765 1030	136,1 212,5 286,1	35,7 54,5 58,2	350,5 534,8 570,8	41,2 - 51,4	50	9,4
<b>NEW</b> CA 315 MD SE W	16099	220-240	190	0,84	2800	1550	430	67	653	54	45	6,6

\* Sound pressure level measured at 3 m in free field conditions with long-cased appliance in delivery mode in accordance with standard EN ISO 9614.

## ENERGY DATA FOR REGULATION N° 1254/2014/UE

	UNIT OF MEASURE	CA 100 MD E W	CA 125 MD E W	CA 150 Q MD E W	CA 150 MD E W
CODE		16120	16121	16122	16133
Supplier's name or trade mark	-	Vortice	Vortice	Vortice	Vortice
SFPint	W(m³/s)	NA*	NA*	NA*	NA*
Declared typology	-	NRVU-U**	NRVU-U**	NRVU-U**	NRVU-U**
Type of drive	-	MSD***	MSD***	MSD***	MSD***
Type of heat recovery system HRS	-	None	None	None	None
Nominal NRVU flow rate	m³/s	0,10994	0,12206	0,12328	0,17025
Effective electric power input	kW	0,050	0,050	0,050	0,081
Face velocity at design flow rate	m/s	13,99856	9,94598	6,97610	9,63418
Nominal external pressure (Δps, ext)	Pa	88	108	137	59
Internal pressure drop of ventilation components (Δps,int)	Pa	44	-6	-40	171
Internal pressure drop of non-ventilation components (Δps,add)	Pa	0	0	0	0
Static efficiency of fans used in accordance with Regulation (EU) N. 327/2011	%	29,0	24,9	23,9	48,2
Declared maximum internal leakage rate of the casing of ventilation units	%	NA*	NA*	NA*	NA*
Declared maximum external leakage rate of the casing of ventilation units	%	NA*	NA*	NA*	NA*
Energy performance or classification of the filters	-	NA*	NA*	NA*	NA*
Description of visual filter warning	-	NA*	NA*	NA*	NA*
Casing sound power level	LWA[dB(A)]	36	39	38	53

\*NA: Not applicable - \*\*RVU-U: Non Residential Ventilation Unit - Unidirectional - \*\*\*MSD: Multi-Speed Drive

**CA MD E W RANGE**  
STEEL SHEET MIXED FLOW WALL FANS

NA\*

**ENERGY DATA FOR REGULATION N° 1254/2014/UE**

	UNIT OF MEASURE	CA 160 MD E W	CA 200 MD E W	CA 250 MD E W	CA 315 MD E W	CA 315 MD SE W
CODE		16134	16135	16136	16137	16099
Supplier's name or trade mark	-	Vortice	Vortice	Vortice	Vortice	Vortice
SFPint	W(m³/s)	NA*	NA*	NA*	NA*	206,48
Declared typology	-	NRVU-U**	NRVU-U**	NRVU-U**	NRVU-U**	NRVU-U**
Type of drive	-	MSD***	MSD***	MSD***	MSD***	MSD***
Type of heat recovery system HRS	-	None	None	None	None	None
Nominal NRVU flow rate	m³/s	0,18356	0,22633	0,28222	0,28083	0,379
Effective electric power input	kW	0,083	0,088	0,127	0,127	0,216
Face velocity at design flow rate	m/s	9,12931	7,20442	5,74939	3,60361	4,8582
Nominal external pressure ( $\Delta p_s$ , ext)	Pa	49	128	108	128	135
Internal pressure drop of ventilation components ( $\Delta p_s$ ,int)	Pa	158	-16	25	8	75
Internal pressure drop of non-ventilation components ( $\Delta p_s$ ,add)	Pa	0	0	0	0	0
Static efficiency of fans used in accordance with Regulation (EU) N. 327/2011	%	45,9	28,7	29,6	30,0	37
Declared maximum internal leakage rate of the casing of ventilation units	%	NA*	NA*	NA*	NA*	NA*
Declared maximum external leakage rate of the casing of ventilation units	%	NA*	NA*	NA*	NA*	0,5
Energy performance or classification of the filters	-	NA*	NA*	NA*	NA*	NA*
Description of visual filter warning	-	NA*	NA*	NA*	NA*	NA*
Casing sound power level	LWA[dB(A)]	53	48	51	51	71

\*NA: Not applicable - \*\*NRVU-U: Non Residential Ventilation Unit - Unidirectional - \*\*\*MSD: Multi-Speed Drive





**DIMENSIONS**

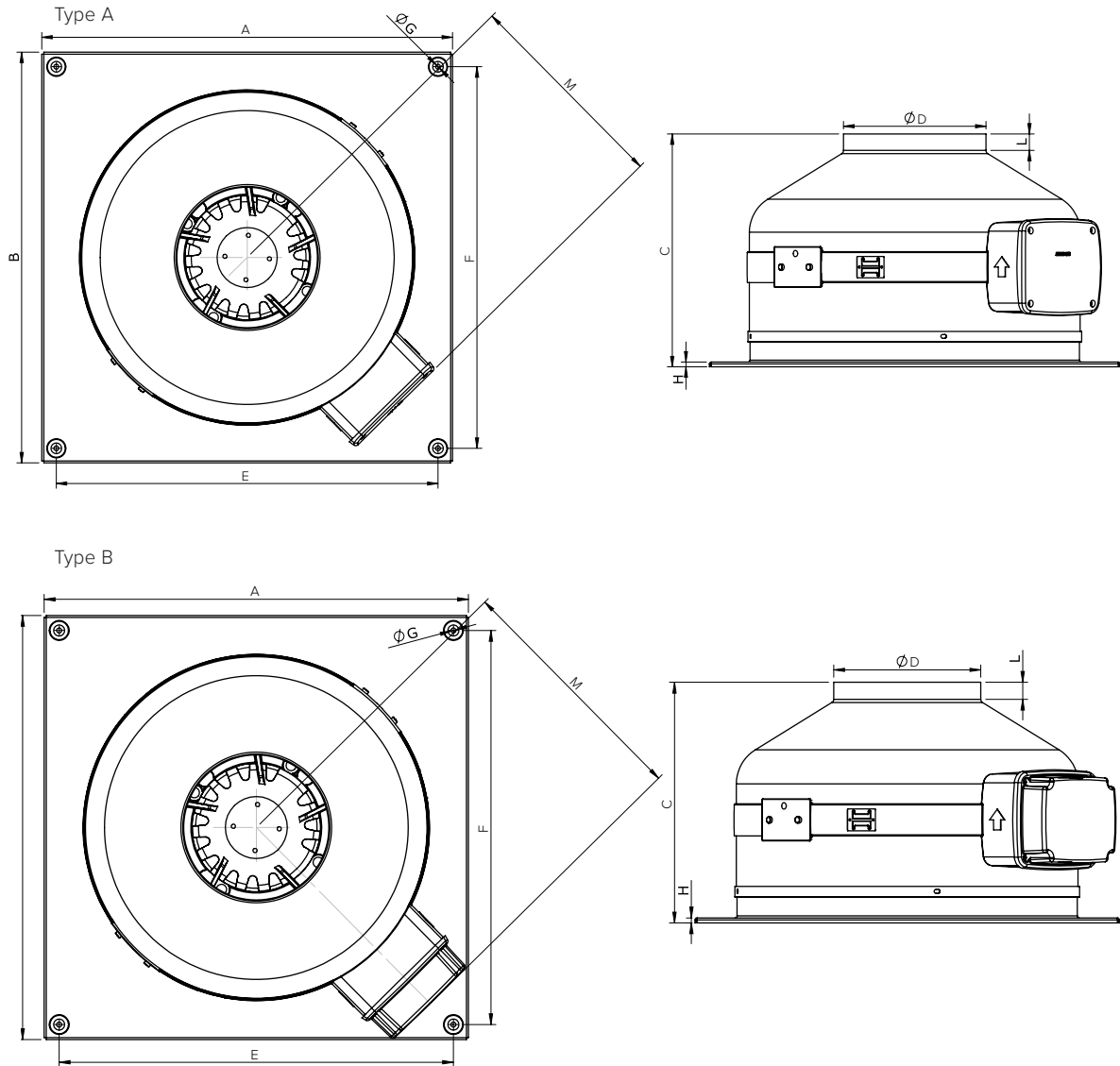

MODELS	TYPE	ØA	B	C	ØD	E	F	G	H	L	M
CA 100 MD E W	B	334	334	210	97	304	304	5	5	15	198
CA 125 MD E W	B	334	334	210	122	304	304	5	5	23	198
CA 150 Q MD E W	B	334	334	210	147	304	304	5	5	30	198
CA 150 MD E W	A	424	424	245	147	394	394	5	5	17	220
CA 160 MD E W	A	424	424	245	157	394	394	5	5	18	220
CA 200 MD E W	A	424	424	245	197	394	394	5	5	20	220
CA 250 MD E W	B	424	424	237	247	394	394	5	5	38	250
CA 315 MD E W	A	489	489	260	312	459	459	5	5	36	252
CA 315 MD SE W	A	489	489	268	312	459	459	5	5	42	252

Dimensions (mm)



**CA MD E W RANGE**  
STEEL SHEET MIXED FLOW WALL FANS

**PERFORMANCE CURVES**

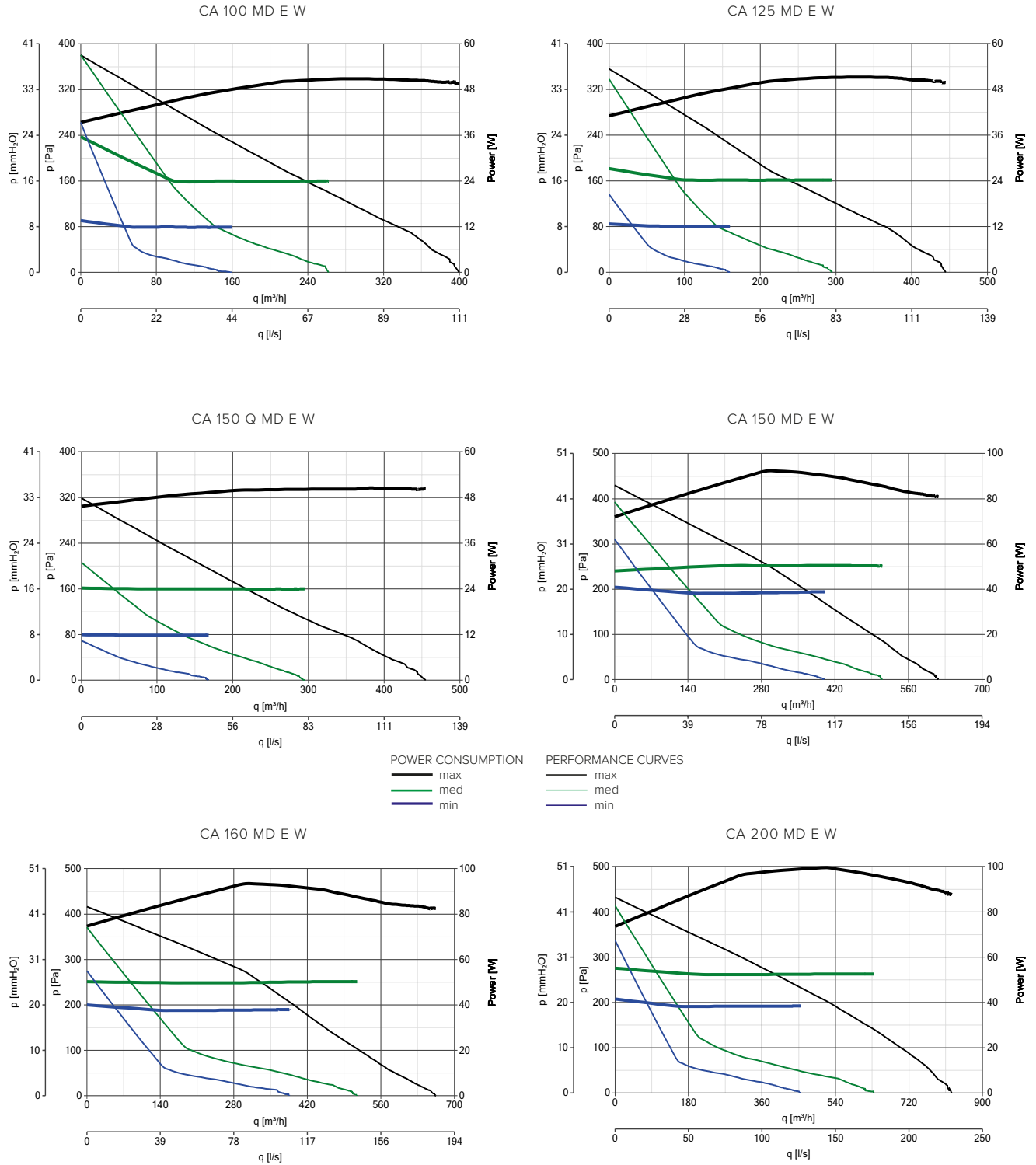





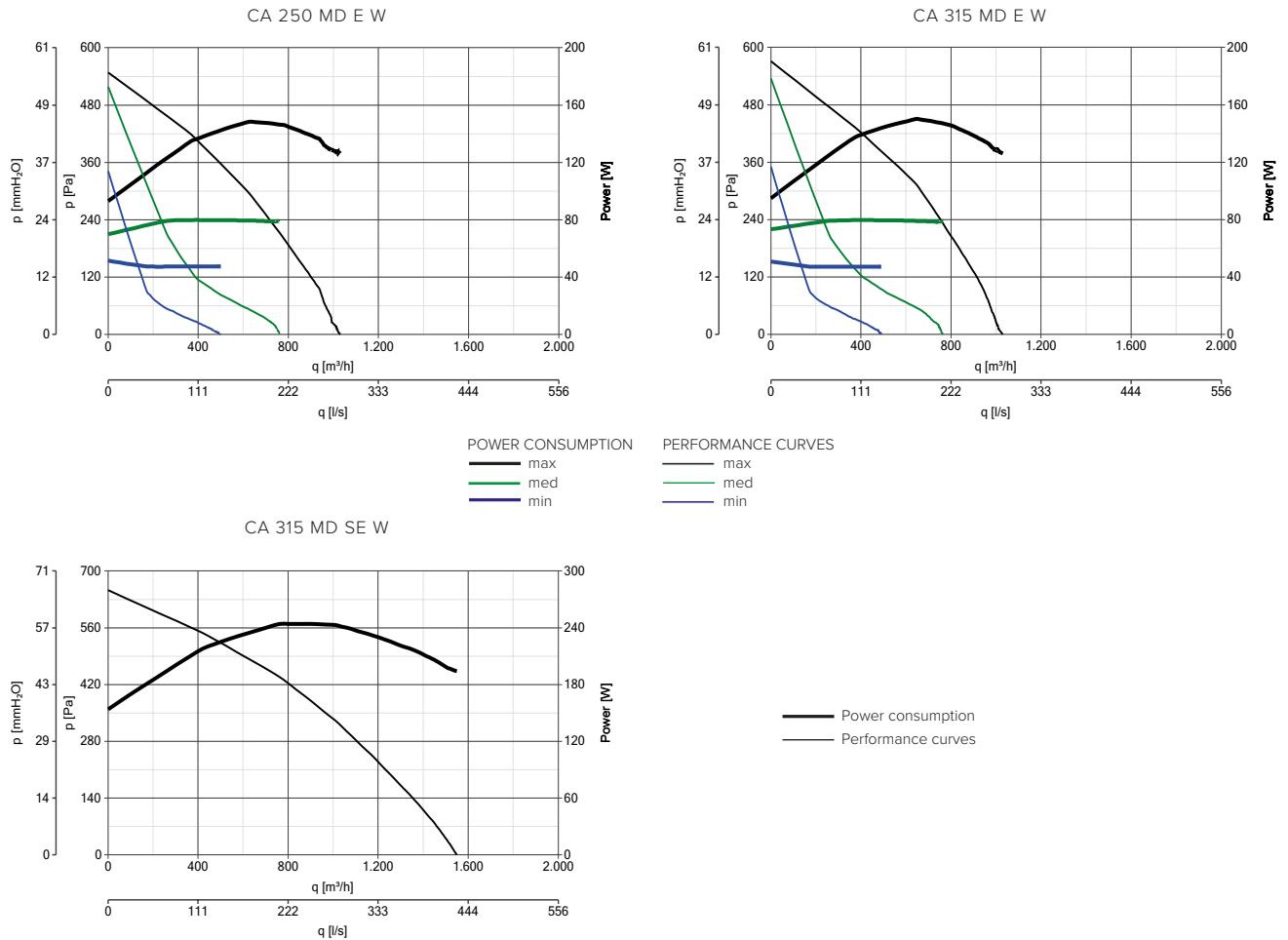



PERFORMANCE CURVES



CONTROLLERS

MODELS	DESCRIPTION	CODE	PRODUCT
	<b>C 1.5</b> - ELECTRONIC SPEED CONTROLLER 1.5 A	12966	ALL PRODUCTS
	<b>C 2.5</b> - ELECTRONIC SPEED CONTROLLER 2.5 A	12967	ALL PRODUCTS
	<b>KIT SCB</b> - BUILT-IN CONTROLLER ADAPTOR	22481	12966 - 12967
	<b>TRIO</b> - 3 SPEED SWITCH FOR WALL AND FLUSH MOUNTING INSIDE UNI 503 STANDARD ELECTRIC BOXES	12869	16120 - 16121 - 16122 - 16133 - 16134 16135 - 16136 - 16137
	<b>IRM5 2B</b> - 5-POSITION SPEED CONTROLLER OF THE AUTOTRANSFORMER TYPE, DESIGNED TO CONTROL SINGLE-PHASE ASYNCHRONOUS MOTORS.	12861	16099

ACCESSORIES ON REQUEST

MODELS	DESCRIPTION	CODE	PRODUCT
	<b>CA-G</b> - PROTECTION GRILLE	100	22750
		125	22755
		150	22760
		160	22762
		200	22765
		250	22770
		315	22775
			16120
			16121
			16122 - 16133
			16134
			16135
			16136
			16137 - 16099





## **CA MD E RF RANGE**

### Painted steel sheet mixed flow roof fans

Painted steel sheet mixed flow roof fans. Installed at the end of the ventilation duct, effectively and economically meet the ventilation needs of commercial or industrial premises (laboratories, bars, restaurants, laundries, gyms, etc.) with a roof-mounted exhaust.

#### **VERSIONS**

8 models, with nominal diameter between 100 and 315 mm.

#### **KEY FEATURES**

- Excellent price-to-performance ratio
- Built to withstand weathering and high temperatures.
- Extremely reliable and low maintenance.
- Wide continuous operation temperature range.
- Fully compliant with Reg. ErP 2018 N. 1253/2014.

#### **TECHNICAL FEATURES**

- Pickled, phosphate-coated steel sheet casing and roof fixing plates that have been painted with polyester paint against aggressive weathering.
- Motor-holder built into the boxes housing the mains connection terminals and the flow conditioner fins, constructed in self-extinguishing plastic resin (V0).
- Plastic resin covering that is resistant to weathering and to ageing induced by UV rays ("UV resistant").
- 3-speed fans that can be set using optional device TRIO-CA (code 12869), composed of:
  - AC motors with thermal overload cut-out and shafts turning on ball bearings to guarantee long lasting continuous service (at least 30,000 h) at the maximum plate temperature.
  - Centrifugal impellers with backward curved blades in heat-resistant plastic resin loaded with glass fibres to combine structural strength and dimensional stability.
- Possibility of connecting to remote environmental temperature, humidity, smoke and presence sensors (optional).
- Performance and safety certified by third party body (IMQ).
- Protection rating from dusts and water: IP44 (appliance ducted in extraction and delivery).
- Insulation Class: II .





## TECHNICAL DATA

Models	Code	V~50/60	Max Airflow					Max Pressure		LP DB(A) 3m*	Max °C	KG
			W min/med/max	A min/med/max	RPM min/med/max	m³/h min/med/max	l/s min/med/max	mmH <sub>2</sub> O min/med/max	Pa min/med/max			
CA 100 MD E RF	16140	220-240	12 24 50	0,13 0,18 0,23	900 1555 2405	95 167 265	26,3 46 73,6	27,7 39,7 39,7	272,2 389,3 389,3	27,3 - 37,5	50	4,6
CA 125 MD E RF	16141	220-240	12 24 50	0,13 0,18 0,23	915 1538 2405	118 200 312	32,7 55,5 86,6	16,5 34,8 36,3	161,8 340,8 356,1	21,5 - 40,2	50	4,6
CA 150 Q MD E RF	16142	220-240	12 24 50	0,13 0,18 0,23	963 1608 2430	122 207 312	33,8 57,5 86,6	7,2 21,7 31,4	70,7 212,8 307,9	23,8 - 37,5	50	7,5
CA 150 MD E RF	16183	220-240	33 45 85	0,33 0,37 0,39	1240 1660 2630	230 310 490	63,8 86,1 136,1	31,3 41,2 44	307,6 404,7 432,1	24,6 - 43,8	55	7,5
CA 160 MD E RF	16184	220-240	33 45 88	0,33 0,37 0,39	1300 1740 2655	245 325 500	68 90 138	20,5 32,9 40,5	201 322,6 400	30,4 - 44,8	55	9
CA 200 MD E RF	16185	220-240	33 45 95	0,33 0,37 0,42	1156 1465 2555	310 395 700	86,1 109,7 194,7	31,9 41,3 44,9	313,4 405,5 440,6	23 - 31,7	55	9,6
CA 250 MD E RF	16186	220-240	48 80 130	0,47 0,57 0,57	1195 1752 2665	385 570 850	106,9 158,3 236,1	39,1 53,2 56,3	384,1 521,5 552,2	28,6 - 43,8	50	10
CA 315 MD E RF	16187	220-240	48 80 130	0,48 0,57 0,57	1186 1755 2590	370 565 865	102,7 156,9 240,2	37,6 55,2 58,5	368,9 542,1 573,7	32,8 - 40,7	50	12
<b>NEW</b> CA 315 MD SE RF	16098	220-240	190	0,84	2800	1220	339	69	673	55	45	6,6

\* Sound pressure level measured at 3 m in free field conditions with long-cased appliance in delivery mode in accordance with standard EN ISO 9614.

## ENERGY DATA FOR REGULATION N° 1254/2014/UE

	UNIT OF MEASURE	CA 100 MD E RF	CA 125 MD E RF	CA 150 Q MD E RF	CA 150 MD E RF	CA 315 MD SE RF
CODE		16140	16141	16142	16183	16098
Supplier's name or trade mark	-	Vortice	Vortice	Vortice	Vortice	Vortice
SFPint	W(m³/s)	NA*	NA*	NA*	NA*	NA*
Declared typology	-	NRVU-U**	NRVU-U**	NRVU-U**	NRVU-U**	NRVU-U**
Type of drive	-	MSD***	MSD***	MSD***	MSD***	MSD***
Type of heat recovery system HRS	-	None	None	None	None	None
Nominal NRVU flow rate	m³/s	0,06967	0,08597	0,08589	0,13508	0,321
Effective electric power input	kW	0,051	0,051	0,050	0,089	0,236
Face velocity at design flow rate	m/s	8,87024	7,00565	4,86032	7,64415	4,348
Nominal external pressure (Δps, ext)	Pa	108	29	29	69	59
Internal pressure drop of ventilation components (Δps,int)	Pa	110	154	154	213	256
Internal pressure drop of non-ventilation components (Δps,add)	Pa	0	0	0	0	0
Static efficiency of fans used in accordance with Regulation (EU) N. 327/2011	%	29,8	30,8	31,4	42,8	43
Declared maximum internal leakage rate of the casing of ventilation units	%	NA*	NA*	NA*	NA*	NA*
Declared maximum external leakage rate of the casing of ventilation units	%	NA*	NA*	NA*	NA*	0,5
Energy performance or classification of the filters	-	NA*	NA*	NA*	NA*	NA*
Description of visual filter warning	-	NA*	NA*	NA*	NA*	NA*
Casing sound power level	LWA[dB(A)]	38	40	38	44	73

\*NA: Not applicable - \*\*RVU-U: Non Residential Ventilation Unit - Unidirectional - \*\*\*MSD: Multi-Speed Drive

**CA MD E RF RANGE**  
PAINTED STEEL SHEET MIXED FLOW ROOF FANS

**DIMENSIONS**

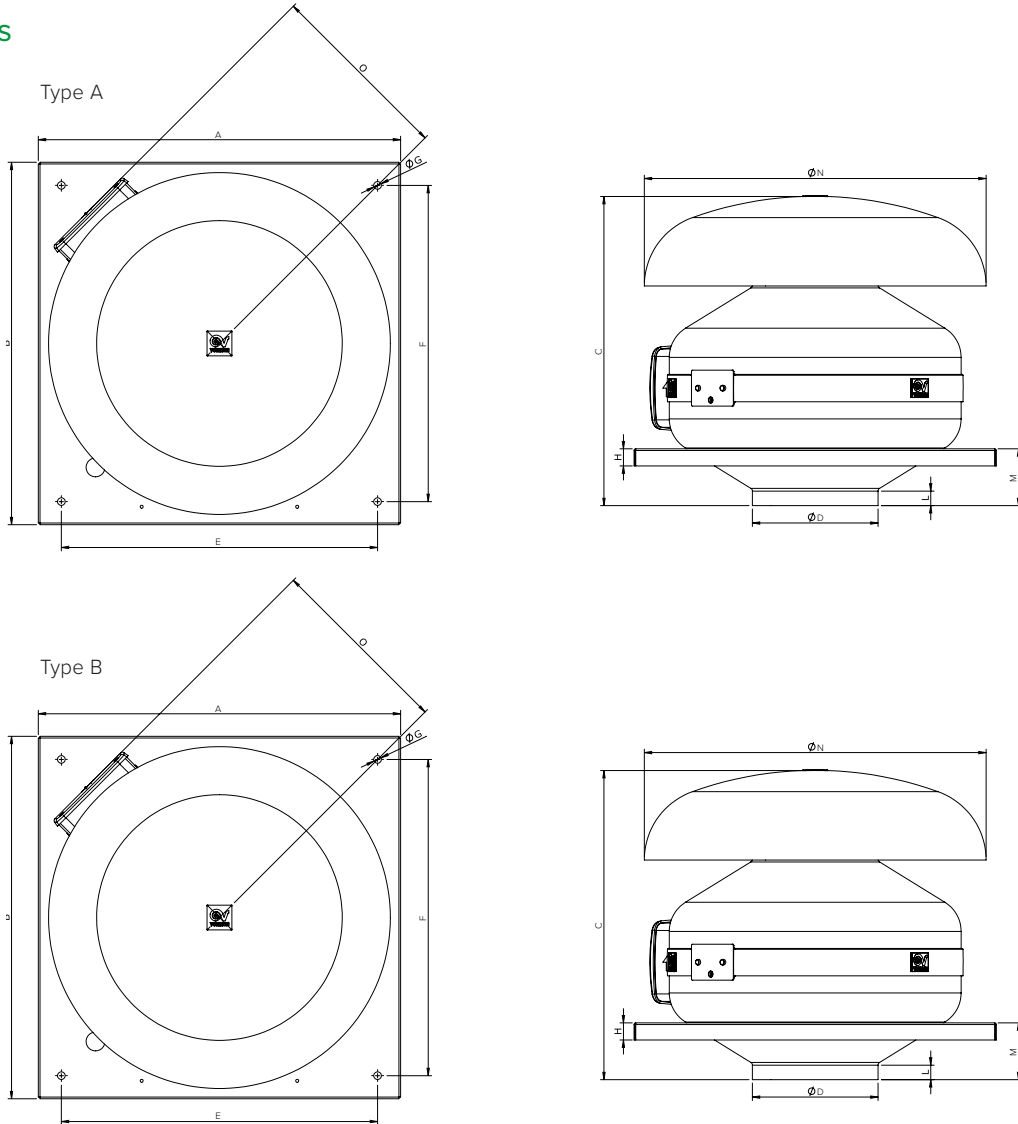

MODELS	TYPE	A	B	C	ØD	E	F	ØG	H	L	M	ØN	O
CA 100 MD E RF	B	334	334	305	97	280	280	9	20	15	35	300	198
CA 125 MD E W	B	334	334	305	122	280	280	9	20	23	35	300	198
CA 150 Q MD E RF	B	334	334	305	147	280	280	9	20	30	35	300	198
CA 150 MD E RF	A	424	424	365	147	370	370	9	20	17	47	400	220
CA 160 MD E RF	B	424	424	365	157	370	370	9	20	18	47	400	250
CA 200 MD E RF	B	424	424	365	197	370	370	9	20	20	49	400	250
CA 250 MD E RF	A	489	489	367	247	435	435	9	20	38	41	400	220
CA 315 MD E RF	A	489	489	415	312	435	435	9	20	36	65	534	250
CA 315 MD SE RF	A	489	489	423	312	435	435	9	20	42	74	534	260

Dimensions (mm)



PERFORMANCE CURVES

CA 100 MD E RF

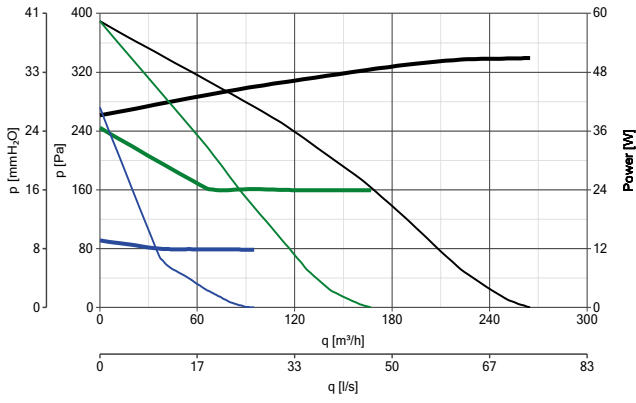

CA 125 MD E RF

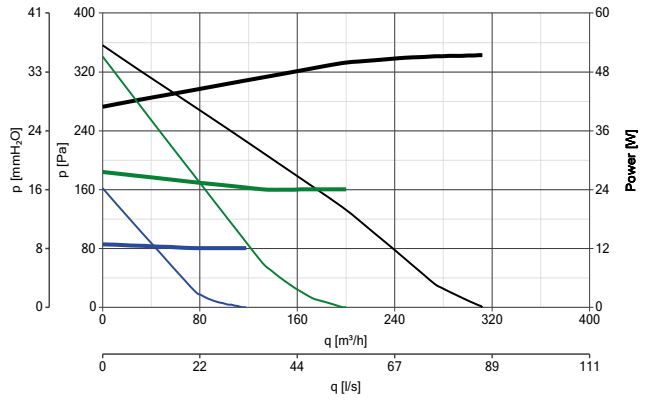

CA 150 Q MD E RF

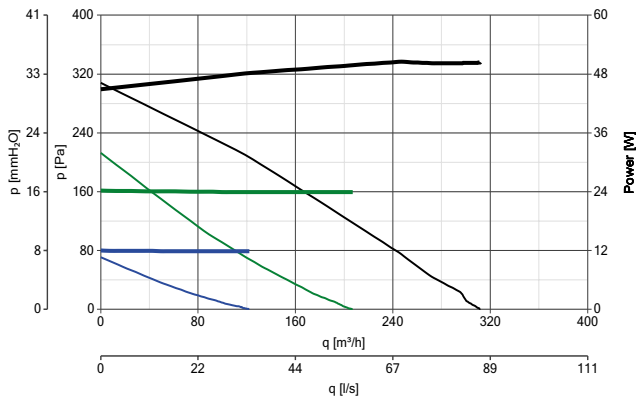

CA 150 MD E RF

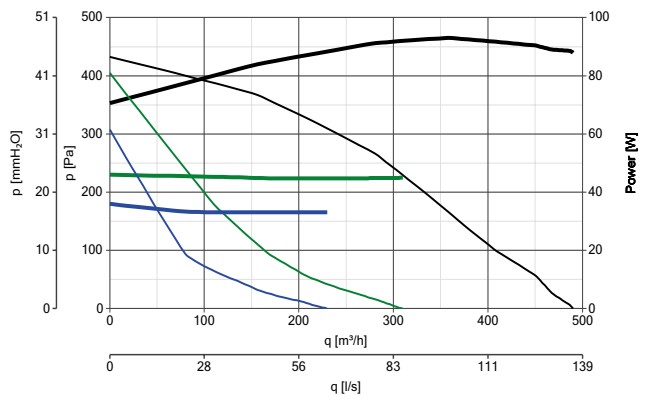

CA 160 MD E RF

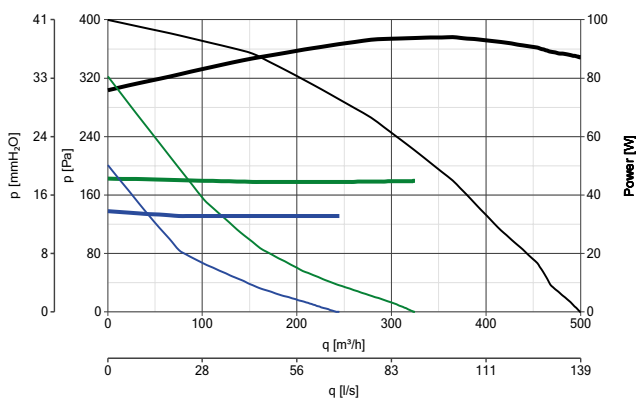

CA 200 MD E RF

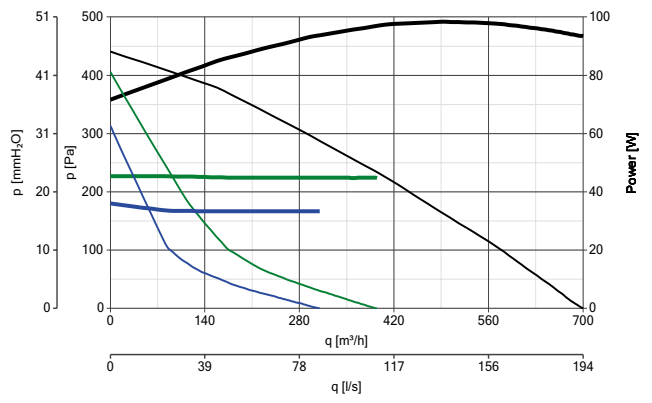

POWER CONSUMPTION      PERFORMANCE CURVES  
 — max                      — max  
 — med                     — med  
 — min                      — min





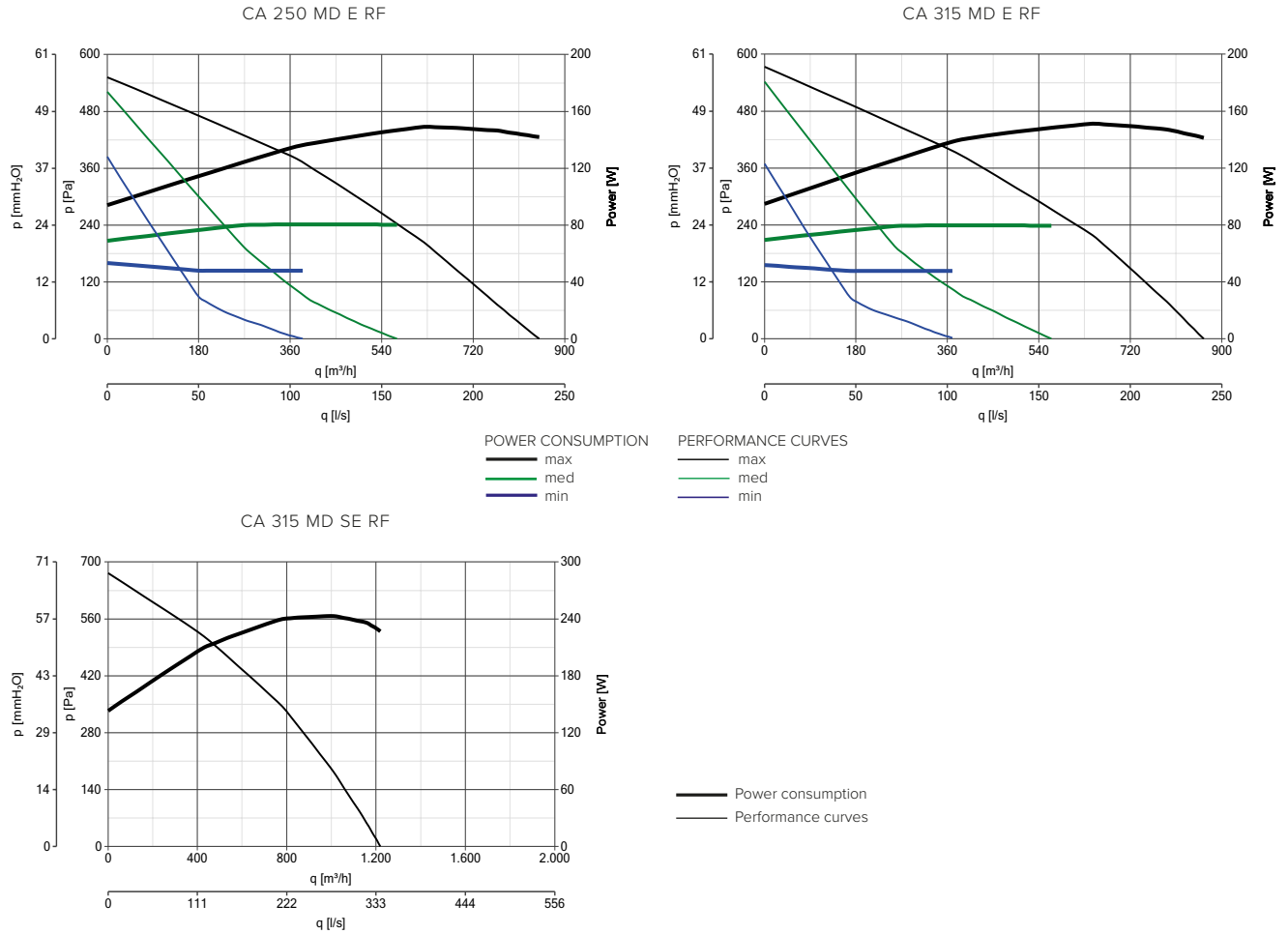

**CA MD E RF RANGE**  
PAINTED STEEL SHEET MIXED FLOW ROOF FANS

**PERFORMANCE CURVES**







## CONTROLLERS

MODELS	DESCRIPTION	CODE	PRODUCT
	<b>C 1.5</b> - ELECTRONIC SPEED CONTROLLER 1.5 A	12966	ALL PRODUCTS
	<b>C 2.5</b> - ELECTRONIC SPEED CONTROLLER 2.5 A	12967	ALL PRODUCTS
	<b>KIT SCB</b> - BUILT-IN CONTROLLER ADAPTOR	22481	12966 - 12967
	<b>TRIO</b> - 3 SPEED SWITCH FOR WALL AND FLUSH MOUNTING INSIDE UNI 503 STANDARD ELECTRIC BOXES	12869	16140 - 16141 - 16142 - 16183 - 16184 16185 - 16186 - 16187
	<b>IRM5 2B</b> - 5-POSITION SPEED CONTROLLER OF THE AUTOTRANSFORMER TYPE, DESIGNED TO CONTROL SINGLE-PHASE ASYNCHRONOUS MOTORS.	12861	16098

## ACCESSORIES ON REQUEST

MODELS	DESCRIPTION	CODE	PRODUCT
		100	22750
		125	22755
		150	22760
	<b>CA-G</b> - PROTECTION GRILLE	160	22762
		200	22765
		250	22770
		315	22775
	<b>CARF-C 125</b> - SUB-FRAME	22543	16140 - 16141
	<b>CARF-C 150/160/200</b> - SUB-FRAME	22544	16142 - 16183 - 16184 - 16185
	<b>CARF-C 250/315</b> - SUB-FRAME	22545	16186 - 16187 - 16098

## CA IN-LINE RANGE

CA IN-LINE are compact centrifugal in-line fans designed to extract low to larger air volumes from residential, commercial and industrial premises like service rooms, wet rooms, offices, laboratories, shops, bars, restaurants, laundries, etc...

Their installation in industrial areas is favored by robust construction (casings are made of galvanized steel sheet) and high (IP44) level of protection against dust and water when ducted. Thanks to their very short height, CA IN-LINE units are ideal for mounting in short false ceilings, while they are fully compatible with installation on wall and ceilings; on this respect, integrated brackets facilitate their commissioning.

Swing-out motorfans facilitate cleaning and extraordinary maintenance. Alternative speed settings (AC versions are equipped with 3 speed motors, while EC models can be adjusted through 0-10 V potentiometers) offer the best compromise among performance, consumption and noise.

### COMPOSITION RANGE

CA IN-LINE range consists of 19 models, nominal diameters between 100 mm and 200 mm, divided into 3 series: CA IN-LINE, CA IN-LINE QUIET and CA IN-LINE QUIET ES, each with alternative type of motorfans and different levels of soundproofing.

### KEY FEATURES

- Easy installation in small spaces thanks to short height.
- Flexible installation, horizontal, vertical and slanted, on walls, ceilings and in false-ceilings, even in the presence of high concentrations of dust or water.
- Quick commissioning: all electrical connections are located inside a highly (IP55) protected box outside the casing.
- Easy maintenance, thanks to the motorfans fixed to the lower covers hinged to the casings to allow them to rotate outwardly.
- Possibility to conveniently adapt the performance according to real needs, for the best balance of airflow, consumption and noise emissions.
- Very low noise emissions (CA IN-LINE QUIET and CA IN-LINE QUIET ES).
- Very low consumptions (CA IN-LINE QUIET ES).
- Long lasting reliability, thanks to high quality, virtually maintenance free motors.





## CONSTRUCTION RANGE



**LONG LIFE** 30.000 h

### 1. TERMINAL BOXES

Highly (IP55) protected against dust and water, are located outside the casings and fitted to power cables to allow their positioning in the most appropriate place, depending on the specific installation needs.

### 2. ROBUST GALVANIZED STEEL SHEET CASINGS

Inner sound proof lining (material and thickness change with the series) to reduce noise emissions. Protection grade IP44 when ducted.

### 3. CIRCULAR SPIGOTS

On supply and extract, equipped with double lip rubber gaskets to avoid air leakages, fitting into standard ducts.

### 5. GALVANIZED STEEL SHEET BRACKETS

Directly fixed to the casing for faster installation.



### 5. MOTOR FANS

Dynamically balanced as a unit; centrifugal impellers with backward curved blades directly coupled with single-phase, external rotors (EC in ES models). Ball bearings to grant long lasting maintenance free operation.

### 4. COVER COVERS

Hinged to the casings and free to rotate downwards and backwards to facilitate access to the attached motorfan, thus granting easier cleaning and extraordinary maintenance.

## CA IN-LINE RANGE

Compact flat in-line centrifugal fans



Suitable for indoor wall-mounted applications at the end of ventilation ducts in residential and industrial environments as factories, hospitals, gyms, restaurants, etc...

### TECHNICAL FEATURES

- Casings made of galvanized steel sheet, robust and resistant to corrosion, highly (IP44) protected against dust and water when ducted; inner sound proof lining, consisting of 10 mm thick PE foam, to reduce noise emissions into adjacent rooms.
- Fixing brackets, made of galvanized steel sheet, integrated in the casings to speed up installation.
- Circular spigots for connection to standard commercial hoses, fitted with a double lip rubber gasket for perfect air tightness.
- Highly efficient backward curved centrifugal impellers directly coupled to single-phase, 3 speed, protected against overheating, external rotor motors. Ball bearings to grant long lasting (at least 30.000 h) continuous duty at the maximum rated temperature. Speed setting through Vortice speed switches (optional); speed control from 0-100% by means of Vortice's electronic speed controllers (optional).
- Electrical connection boxes, made of plastic resin, shock proof and resistant to aggressive agents, with a very high (IP55 protection against dust and water).
- Protection against dust and water: IP44 (when ducted).
- Electric insulation class: I (grounding mandatory).

### TECHNICAL DATA

Models	Code	V 50/60Hz	W* max/mid/min			A max	Max airflow*						Max pressure*			Max* °C	Kg			
							m³/h max/mid./min.			l/s max/mid/min			mmH <sub>2</sub> O max/mid/min					Pa max/mid/min		
CA-IL 100	16250	230	50	33	18	0,22	250	200	120	69	55	33	35,7	32,8	17,7	350	315	170	40	5,4
CA-IL 125	16251	230	50	33	18	0,22	310	250	160	86	69	44	35,7	33,8	19,7	350	325	190	40	5,4
CA-IL 150 Q	16252	230	50	33	18	0,23	350	280	160	97	78	44	30,6	29,1	15,1	300	280	145	40	5,8
CA-IL 150	16254	230	100	65	49	0,44	460	320	230	128	89	64	44,1	33,3	19,2	435	320	185	40	6,2
CA-IL 160 Q	16253	230	50	33	18	0,23	350	250	160	97	69	44	30,6	27	22,9	300	260	220	40	6
CA-IL 160	16255	230	100	70	50	0,46	460	330	250	128	92	69	45,9	42,7	32,2	450	410	310	40	6
CA-IL 200	16256	230	140	85	50	0,61	830	600	410	231	167	114	55,3	50	34,8	550	480	335	40	9,4

\* Values referred to 230V/50Hz





## ENERGY DATA FOR REGULATION N° 1254/2014/UE

	UNIT OF MEASURE	CA-IL 100	CA-IL 125	CA-IL 150 Q	CA-IL 150
<b>CODE</b>		16250	16251	16252	16254
Supplier's name or trade mark	-	Vortice	Vortice	Vortice	Vortice
SFPint	W(m³/s)	690,92	564,90	470,53	771,93
Declared typology	-	NRVU-U**	NRVU-U**	NRVU-U**	NRVU-U**
Type of drive	-	MSD***	MSD***	MSD***	MSD***
Type of heat recovery system HRS	-	None	None	None	None
Nominal NRVU flow rate	m³/s	0,0661	0,0803	0,889	0,1225
Effective electric power input	kW	0,050	0,050	0,050	0,100
Face velocity at design flow rate	m/s	8,471	6,541	5,030	6,9320
Nominal external pressure ( $\Delta p_s$ , ext)	Pa	19	18	29	16
Internal pressure drop of ventilation components ( $\Delta p_s$ ,int)	Pa	200	175	148	278
Internal pressure drop of non-ventilation components ( $\Delta p_s$ ,add)	Pa	0	0	0	0
Static efficiency of fans used in accordance with Regulation (EU) N. 327/2011	%	29	31	31,5	36,0
Declared maximum internal leakage rate of the casing of ventilation units	%	NA*	NA*	NA*	NA*
Declared maximum external leakage rate of the casing of ventilation units	%	NA*	NA*	NA*	NA*
Energy performance or classification of the filters	-	NA*	NA*	NA*	NA*
Description of visual filter warning	-	NA*	NA*	NA*	NA*
Casing sound power level	LWA[dB(A)]	51	51	53	57

\*NA: Not applicable - \*\*RVU-U: Non Residential Ventilation Unit - Unidirectional - \*\*\*MSD: Multi-Speed Drive

	UNIT OF MEASURE	CA-IL160 Q	CA-IL 160	CA-IL 200
<b>CODE</b>		16253	16255	16256
Supplier's name or trade mark	-	Vortice	Vortice	Vortice
SFPint	W(m³/s)	518,36	835,83	569,95
Declared typology	-	NRVU-U**	NRVU-U**	NRVU-U**
Type of drive	-	MSD***	MSD***	MSD***
Type of heat recovery system HRS	-	None	None	None
Nominal NRVU flow rate	m³/s	0,0781	0,1186	0,2183
Effective electric power input	kW	0,050	0,105	0,141
Face velocity at design flow rate	m/s	3,882	5,8992	6,9497
Nominal external pressure ( $\Delta p_s$ , ext)	Pa	38	17	34
Internal pressure drop of ventilation components ( $\Delta p_s$ ,int)	Pa	161	287	255
Internal pressure drop of non-ventilation components ( $\Delta p_s$ ,add)	Pa	0	0	0
Static efficiency of fans used in accordance with Regulation (EU) N. 327/2011	%	31,1	34,3	44,8
Declared maximum internal leakage rate of the casing of ventilation units	%	NA*	NA*	NA*
Declared maximum external leakage rate of the casing of ventilation units	%	NA*	NA*	NA*
Energy performance or classification of the filters	-	NA*	NA*	NA*
Description of visual filter warning	-	NA*	NA*	NA*
Casing sound power level	LWA[dB(A)]	54	57	62

\*NA: Not applicable - \*\*RVU-U: Non Residential Ventilation Unit - Unidirectional - \*\*\*MSD: Multi-Speed Drive

**CA IN-LINE RANGE**  
COMPACT FLAT IN-LINE CENTRIFUGAL FANS

**SOUNDS LEVELS**

Models	Breakout sound power LwA dB(A)			Sound pressure Lp <sub>3m</sub> * dB(A)			Sound power on extract dB(A)			Sound power on supply dB(A)		
	Max Speed	Mid. Speed	Min. Speed	Max Speed	Mid. Speed	Min. Speed	Max Speed	Mid. Speed	Min. Speed	Max Speed	Mid. Speed	Min. Speed
CA-IL 100	51	45	34	30,5	24,5	13,5	60	57	42	64	60	46
CA-IL 125	52	46	35	31,5	25,5	14,5	60	56	42	72	63	52
CA-IL 150 Q	53	48	36	32,5	27,5	15,5	61	54	41	65	58	45
CA-IL 150	57	50	42	36,5	29,5	21,5	67	60	51	70	63	54
CA-IL 160 Q	54	46	38	33,7	25,6	17,4	62	54	41	63	58	44
CA-IL 160	57	50	42	36,5	29,5	21,5	67	57	48	69	60	51
CA-IL 200	62	50	40	41,5	29,5	19,5	71	59	49	78	67	54

*\*Calculated in free field conditions at 3 m distance in accordance with EN ISO 3741 standard.*





### DIMENSIONS

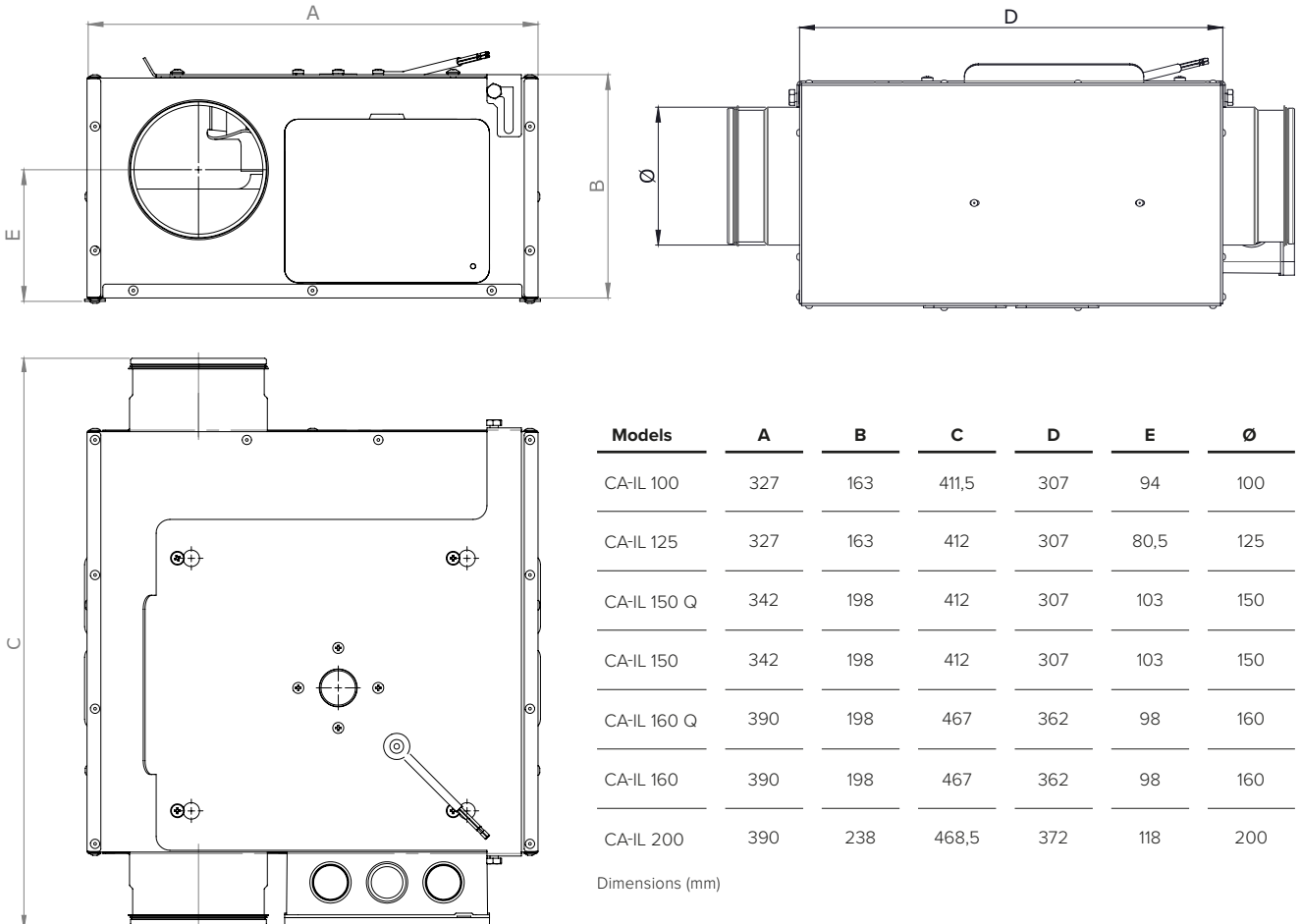

### PERFORMANCE CURVES

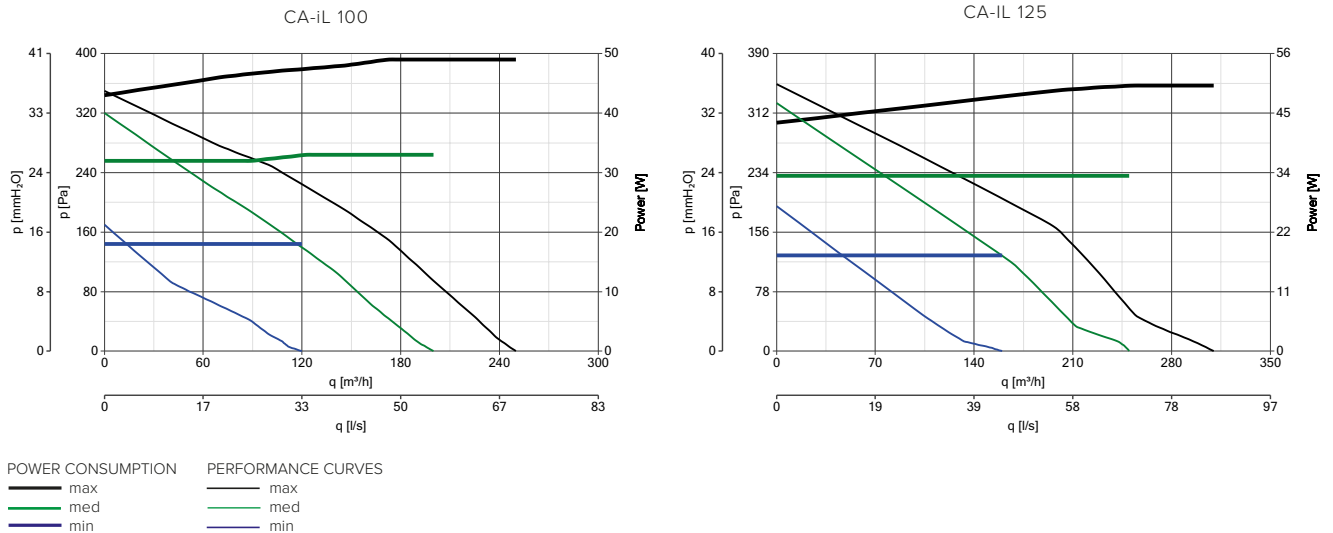

**CA IN-LINE RANGE**  
**COMPACT FLAT IN-LINE CENTRIFUGAL FANS**

**PERFORMANCE CURVES**

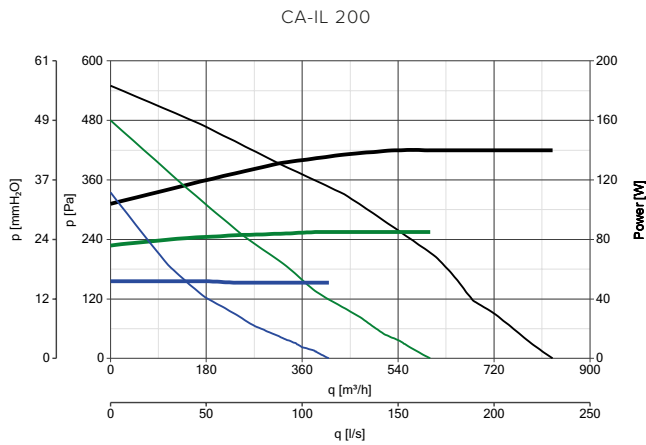
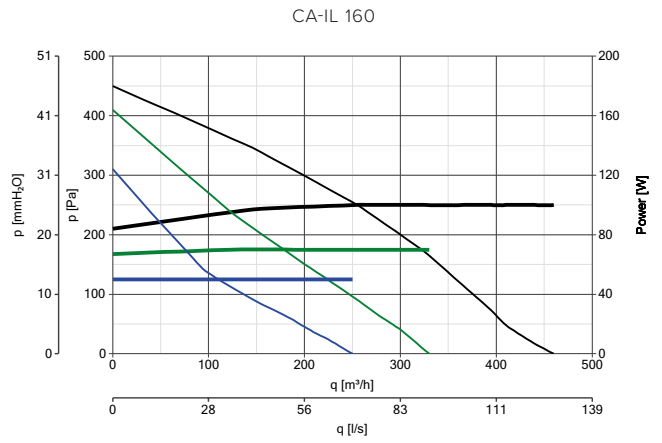
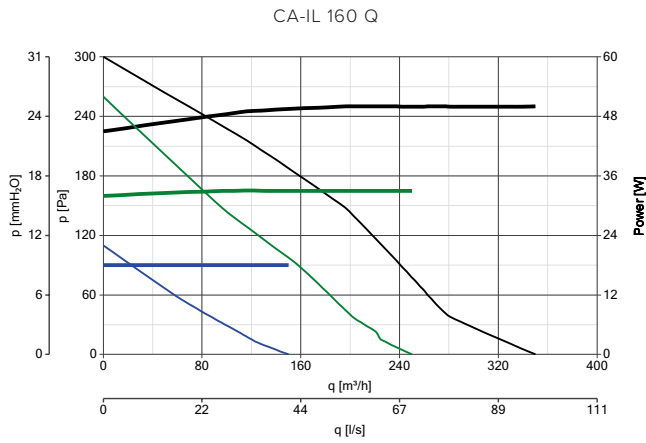
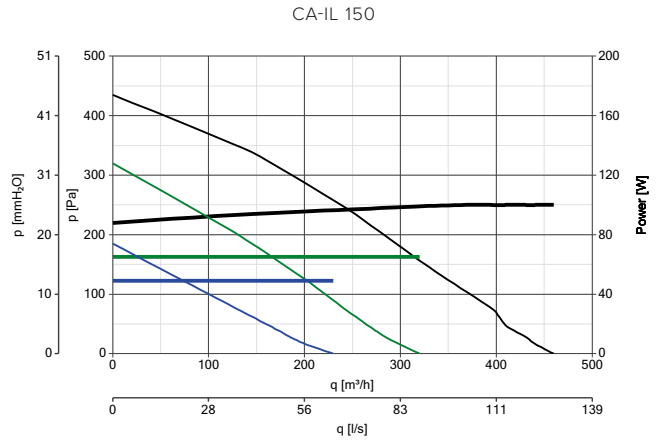
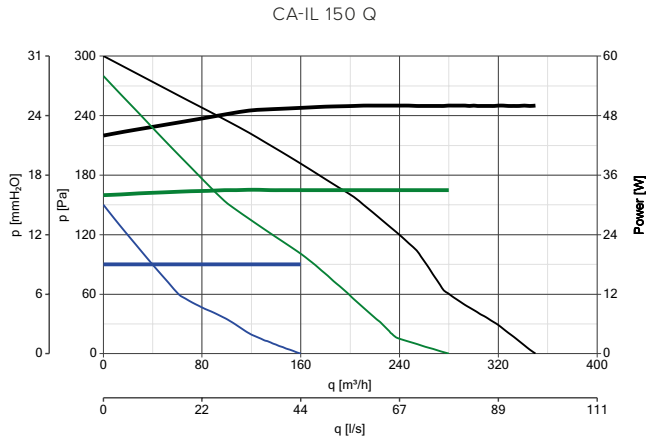







<b>POWER CONSUMPTION</b>	<b>PERFORMANCE CURVES</b>
— max	— max
— med	— med
— min	— min









## CONTROLLERS

MODELS	DESCRIPTION	CODE	PRODUCT
	<b>C 1.5</b> - ELECTRONIC SPEED CONTROLLER 1.5 A	12966	ALL PRODUCTS
	<b>KIT SCB</b> - BUILT-IN CONTROLLER ADAPTOR	22481	12966
	<b>POT-IT</b> - POTENTIOMETER	12826	ALL PRODUCTS
	<b>POT</b> - POTENTIOMETER	12828	ALL PRODUCTS
	<b>TRIO</b> - 3 SPEED SWITCH FOR WALL AND FLUSH MOUNTING INSIDE UNI 503 STANDARD ELECTRIC BOXES	21196	ALL PRODUCTS
	<b>TRIO D</b> - 3 SPEED SWITCH FOR WALL AND FLUSH MOUNTING INSIDE DIN STANDARD ELECTRIC BOXES	12866	ALL PRODUCTS
	<b>IREM D</b> - ELECTRONIC STEPLESS SPEED SWITCH FOR WALL AND FLUSH MOUNTING INSIDE DIN STANDARD ELECTRIC BOX	12867	ALL PRODUCTS

## ACCESSORIES ON REQUEST

MODELS	DESCRIPTION	CODE	PRODUCT
		100	21177
		125	21178
	<b>GR</b> - PROTECTIVE METAL GRIDS (TO BE ASSEMBLED ON THE PRODUCT)	150	21179
		160	21180
		200	21181
		100	21182
		125	21183
	<b>FS</b> - FLEXIBLE SLEEVES WITH CLAMPS FOR HOSE FASTENING	150	21184
		160	21185
		200	21186
	<b>TRA 250</b> - OUTLET PORT PROTECTION GRILLES - FITTED TO THE APPLIANCE INTAKE TO PREVENT ACCIDENTAL CONTACT WITH MOVING PARTS IF THE APPLIANCE IS INSTALLED IN AN ACCESSIBLE POSITION	51150	16253 - 16255 - 16256
	<b>PGR 250</b> - PLASTIC MADE GRAVITY SHUTTERS	50150	16253 - 16255 - 16256

## CA IN-LINE QUIET RANGE

Soundproof compact flat in-line centrifugal fans

Suitable for indoor wall-mounted applications at the end of ventilation ducts in residential and industrial environments as factories, hospitals, gyms, restaurants, etc...

### TECHNICAL FEATURES

- Casings made of galvanized steel sheet, robust and resistant to corrosion, highly (IP44) protected against dust and water when ducted; improved inner sound proof lining, consisting of 50 mm thick melamine coating, to dramatically reduce noise emissions into adjacent rooms.
- Fixing brackets, made of galvanized steel sheet, integrated in the casings to speed up installation.
- Circular spigots for connection to standard commercial hoses, fitted with a double lip rubber gasket for perfect air tightness.
- Highly efficient backward curved centrifugal impellers directly coupled to single-phase, 3 speed, protected against overheating, external rotor motors. Ball bearings to grant long lasting (at least 30.000 h) continuous duty at the maximum rated temperature. Speed setting through Vortice speed switches (optional); speed control from 0-100% by means of Vortice's electronic speed controllers (optional).
- Electrical connection boxes, made of plastic resin shock proof and resistant to aggressive agents, with a very high (IP55) protection against dust and water.
- Protection against dust and water: IP44 (when ducted).
- Electric insulation class: I (grounding mandatory).

### TECHNICAL DATA

Models	Code	V 50/60Hz	W* max/med/min			A max	Max airflow*						Max pressure*			Max °C	Kg			
							m <sup>3</sup> /h max/med/min		l/s max		mmH <sub>2</sub> O max/med/min		Pa max/med/min							
CA-IL100 QUIET	16260	230	50	33	18	0,22	250	200	120	69	55	33	35,7	32,8	17,7	350	315	170	40	5,6
CA-IL125 QUIET	16261	230	50	33	18	0,22	310	250	160	86,1	69	44	35,7	33,8	19,7	350	325	190	40	5,6
CA-IL150 Q QUIET	16262	230	50	33	18	0,23	350	280	160	97,2	97	44	30,6	29,1	15,1	300	280	145	40	6
CA-IL150 QUIET	16264	230	100	65	49	0,44	460	320	230	128	89	64	44,1	33,3	19,2	435	320	185	40	6
CA-IL160 Q QUIET	16263	230	50	33	18	0,23	350	250	160	97	64	69	30,6	27	22,9	300	260	220	40	6,2
CA-IL160 QUIET	16265	230	100	70	50	0,46	460	330	250	128	92	69	45,9	42,7	32,2	450	410	310	40	6,2
CA-IL200 QUIET	16266	230	140	85	50	0,61	830	600	410	231	167	114	55,3	50	3,8	550	480	335	40	9,6

\* Values referred to 230V/50Hz



## ENERGY DATA FOR REGULATION N° 1254/2014/UE

CODE	UNIT OF MEASURE	CA-IL 100 QUIET	CA-IL 125 QUIET	CA-IL 150 Q QUIET	CA-IL 150 QUIET
Supplier's name or trade mark	-	Vortice	Vortice	Vortice	Vortice
SFPint	W(m³/s)	690,92	564,90	470,53	771,93
Declared typology	-	NRVU-U**	NRVU-U**	NRVU-U**	NRVU-U**
Type of drive	-	MSD***	MSD***	MSD***	MSD***
Type of heat recovery system HRS	-	None	None	None	None
Nominal NRVU flow rate	m³/s	0,0661	0,0803	0,0889	0,1225
Effective electric power input	kW	0,050	0,050	0,050	0,100
Face velocity at design flow rate	m/s	8,417	6,541	5,030	6,9320
Nominal external pressure ( $\Delta p_s$ , ext)	Pa	19	18	29	16
Internal pressure drop of ventilation components ( $\Delta p_s$ ,int)	Pa	200	175	148	278
Internal pressure drop of non-ventilation components ( $\Delta p_s$ ,add)	Pa	0	0	0	0
Static efficiency of fans used in accordance with Regulation (EU) N. 327/2011	%	29	31	31,5	36,0
Declared maximum internal leakage rate of the casing of ventilation units	%	NA*	NA*	NA*	NA*
Declared maximum external leakage rate of the casing of ventilation units	%	NA*	NA*	NA*	NA*
Energy performance or classification of the filters	-	NA*	NA*	NA*	NA*
Description of visual filter warning	-	NA*	NA*	NA*	NA*
Casing sound power level	LWA[dB(A)]	51	51	51	55

\*NA: Not applicable - \*\*RVU-U: Non Residential Ventilation Unit - Unidirectional - \*\*\*MSD: Multi-Speed Drive

CODE	UNIT OF MEASURE	CA-IL160 Q QUIET	CA-IL 160 QUIET	CA-IL 200 QUIET
Supplier's name or trade mark	-	Vortice	Vortice	Vortice
SFPint	W(m³/s)	518,36	835,83	569,95
Declared typology	-	NRVU-U**	NRVU-U**	NRVU-U**
Type of drive	-	MSD***	MSD***	MSD***
Type of heat recovery system HRS	-	None	None	None
Nominal NRVU flow rate	m³/s	0,0781	0,1186	0,2183
Effective electric power input	kW	0,050	0,105	0,141
Face velocity at design flow rate	m/s	3,882	5,8992	6,9497
Nominal external pressure ( $\Delta p_s$ , ext)	Pa	38	17	34
Internal pressure drop of ventilation components ( $\Delta p_s$ ,int)	Pa	161	287	255
Internal pressure drop of non-ventilation components ( $\Delta p_s$ ,add)	Pa	0	0	0
Static efficiency of fans used in accordance with Regulation (EU) N. 327/2011	%	31,1	34,3	44,8
Declared maximum internal leakage rate of the casing of ventilation units	%	NA*	NA*	NA*
Declared maximum external leakage rate of the casing of ventilation units	%	NA*	NA*	NA*
Energy performance or classification of the filters	-	NA*	NA*	NA*
Description of visual filter warning	-	NA*	NA*	NA*
Casing sound power level	LWA[dB(A)]	49	55	59

\*NA: Not applicable - \*\*RVU-U: Non Residential Ventilation Unit - Unidirectional - \*\*\*MSD: Multi-Speed Drive

**CA IN-LINE QUIET RANGE**  
SOUNDPROOF COMPACT FLAT IN-LINE CENTRIFUGAL FANS

**SOUNDS LEVELS**

Models	Breakout sound power LwA dB(A)			Sound pressure Lp <sub>3m</sub> * dB(A)			Sound power on extract dB(A)			Sound power on supply dB(A)		
	Max Speed	Mid. Speed	Min. Speed	Max Speed	Mid. Speed	Min. Speed	Max Speed	Mid. Speed	Min. Speed	Max Speed	Mid. Speed	Min. Speed
CA-IL 100 QUIET	51	44	30	30,5	23,5	9,5	52	47	34	63	59	44
CA-IL 125 QUIET	51	44	34	30,5	23,5	13,5	52	49	34	64	60	45
CA-150 Q QUIET	51	44	33	30,5	23,5	12,5	53	45	32	64	57	44
CA-IL 150 QUIET	55	47	40	34,5	26,5	19,5	63	50	42	71	59	51
CA-IL 160 Q QUIET	49	44	33	28,5	23,5	12,5	51	46	33	64	58	44
CA-IL 160 QUIET	55	47	40	34,5	26,5	19,5	60	48	40	68	58	49
CA-IL 200 QUIET	59	50	37	38,5	29,5	16,5	66	53	44	76	65	54

\*Calculated in free field conditions at 3 m distance in accordance with EN ISO 3741 standard.







### DIMENSIONS

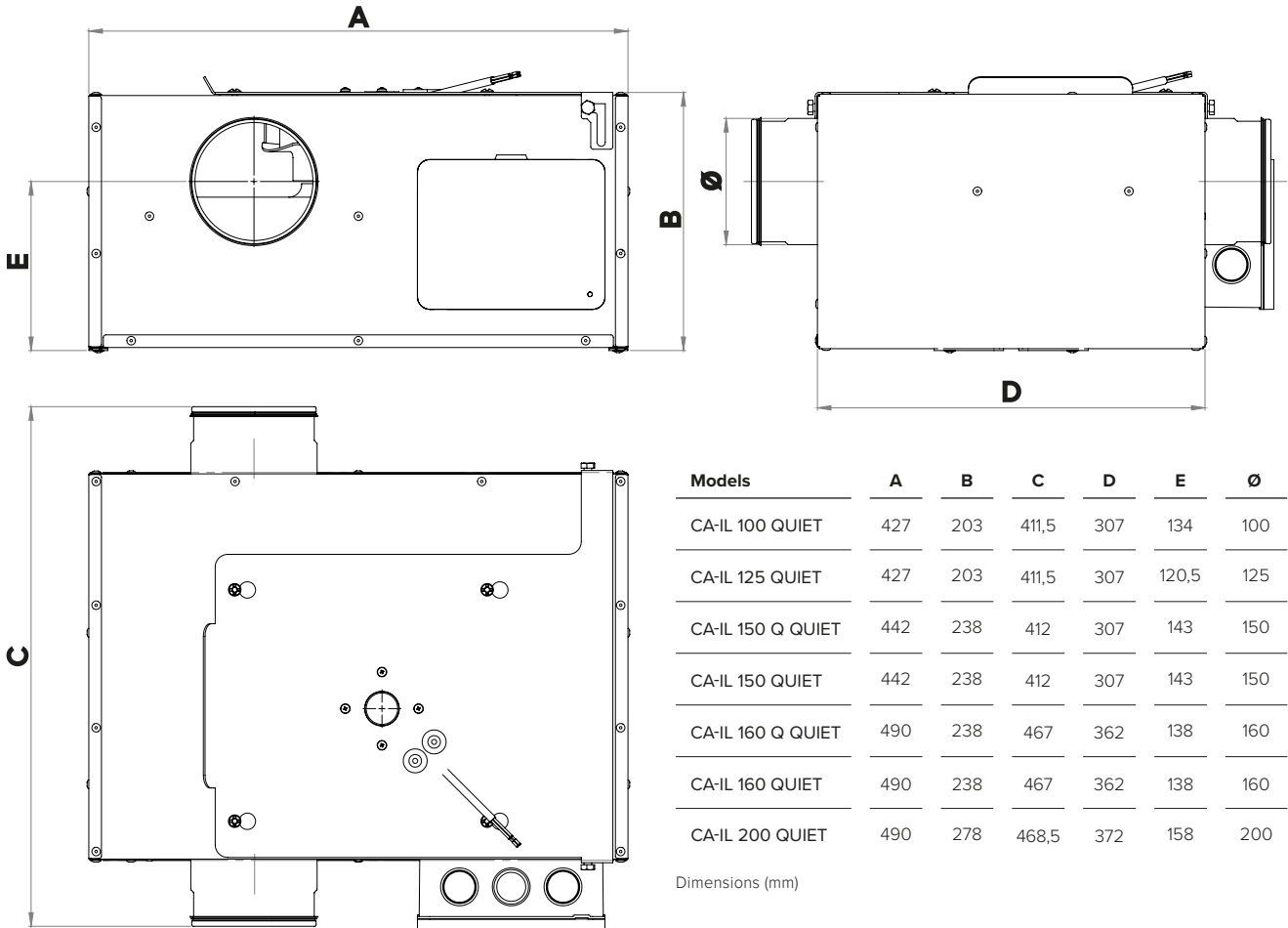

### PERFORMANCE CURVES

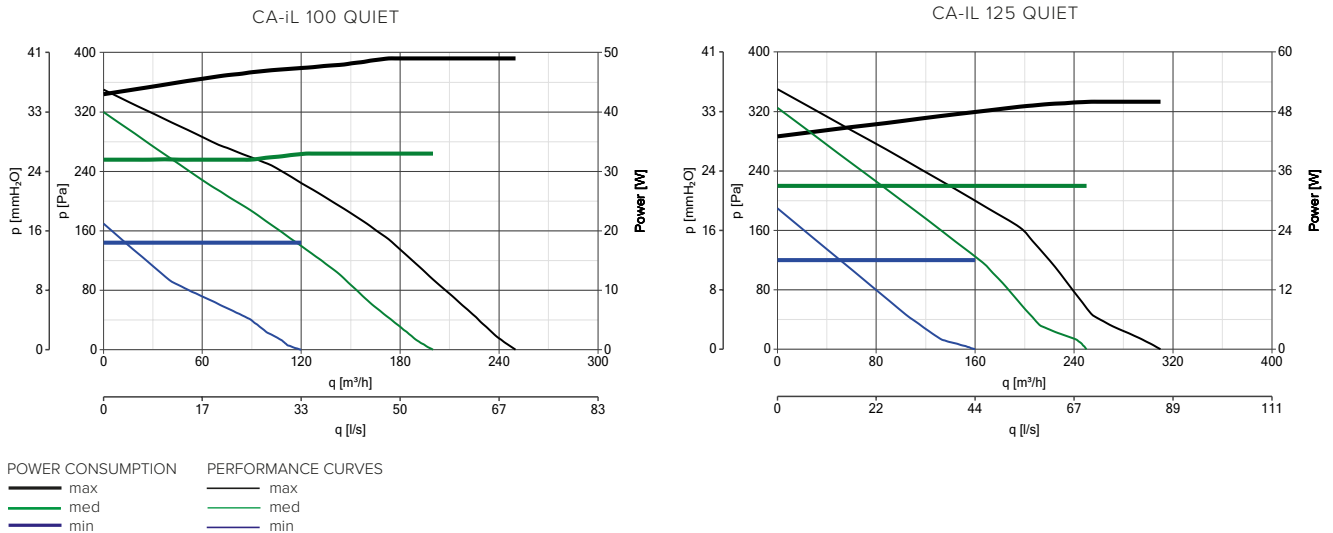

**CA IN-LINE QUIET RANGE**  
SOUNDPROOF COMPACT FLAT IN-LINE CENTRIFUGAL FANS

**PERFORMANCE CURVES**

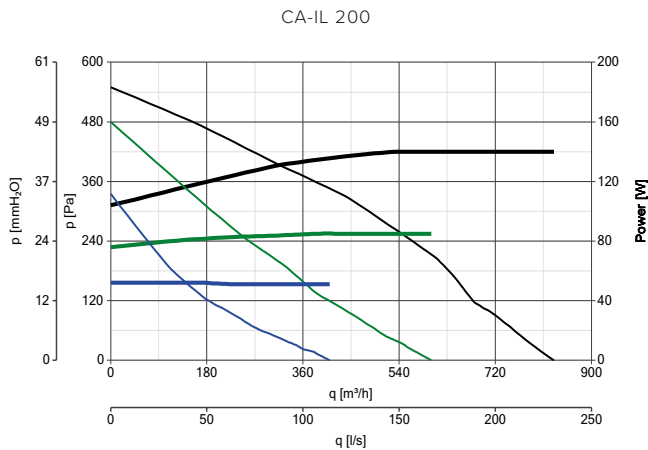
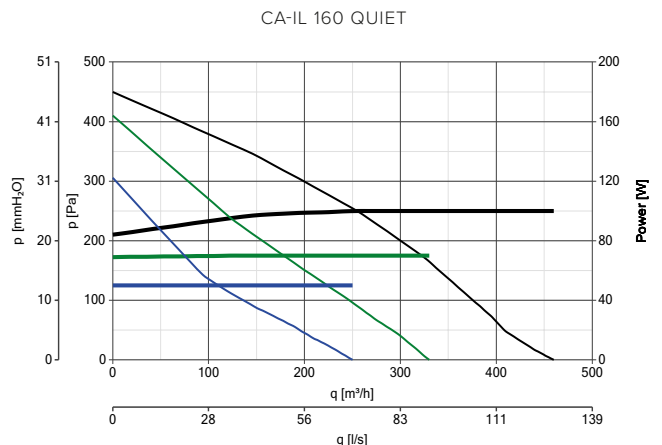
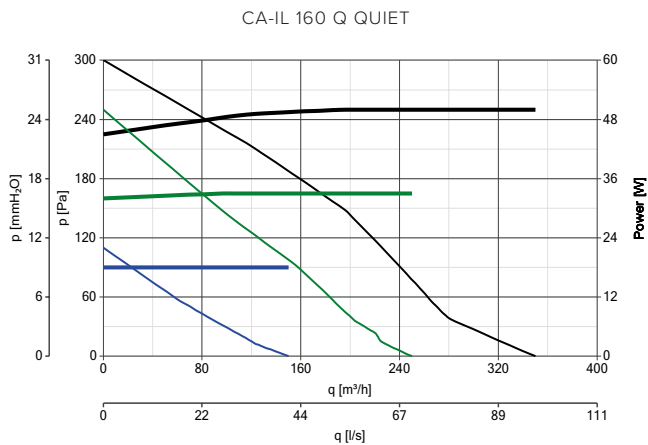
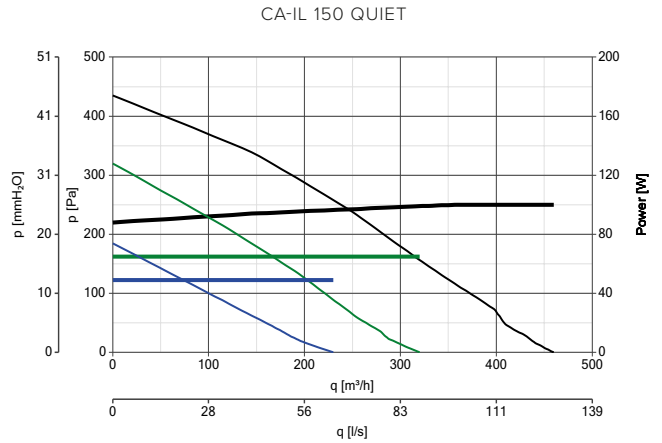
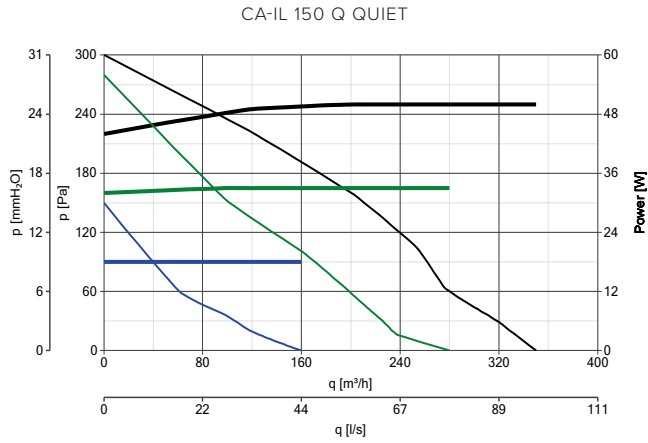







<b>POWER CONSUMPTION</b>	<b>PERFORMANCE CURVES</b>
— max	— max
— med	— med
— min	— min









## CONTROLLERS

MODELS	DESCRIPTION	CODE	PRODUCT
	<b>C 1.5</b> - ELECTRONIC SPEED CONTROLLER 1.5 A	12966	ALL PRODUCTS
	<b>KIT SCB</b> - BUILT-IN CONTROLLER ADAPTOR	22481	12966
	<b>POT-IT</b> - POTENTIOMETER	12826	ALL PRODUCTS
	<b>POT</b> - POTENTIOMETER	12828	ALL PRODUCTS
	<b>TRIO</b> - 3 SPEED SWITCH FOR WALL AND FLUSH MOUNTING INSIDE UNI 503 STANDARD ELECTRIC BOXES	21196	ALL PRODUCTS
	<b>TRIO D</b> - 3 SPEED SWITCH FOR WALL AND FLUSH MOUNTING INSIDE DIN STANDARD ELECTRIC BOXES	12866	ALL PRODUCTS
	<b>IREM D</b> - ELECTRONIC STEPLESS SPEED SWITCH FOR WALL AND FLUSH MOUNTING INSIDE DIN STANDARD ELECTRIC BOX	12867	ALL PRODUCTS

## ACCESSORIES ON REQUEST

MODELS	DESCRIPTION	CODE	PRODUCT
		100	21177 16250
		125	21178 16251
	<b>GR</b> - PROTECTIVE METAL GRIDS (TO BE ASSEMBLED ON THE PRODUCT)	150	21179 16252 - 16254
		160	21180 16253 - 16255
		200	21181 16256
		100	21182 16250
		125	21182 16251
	<b>FS</b> - FLEXIBLE SLEEVES WITH CLAMPS FOR HOSE FASTENING	150	21183 16252 - 16254
		160	21185 16253 - 16255
		200	21186 16256
	<b>TRA 250</b> - OUTLET PORT PROTECTION GRILLES - FITTED TO THE APPLIANCE INTAKE TO PREVENT ACCIDENTAL CONTACT WITH MOVING PARTS IF THE APPLIANCE IS INSTALLED IN AN ACCESSIBLE POSITION	51150	16265 - 16266
	<b>PGR 250</b> - PLASTIC MADE GRAVITY SHUTTERS	50150	16265 - 16266

## CA IN-LINE QUIET ES RANGE

Soundproof compact flat in-line centrifugal EC fans

Suitable for indoor wall-mounted applications at the end of ventilation ducts in residential and industrial environments as factories, hospitals, gyms, restaurants, etc...

### TECHNICAL FEATURES

- Casings made of galvanized steel sheet, robust and resistant to corrosion, highly (IP44) protected against dust and water when ducted; improved inner sound proof lining, consisting of 50 mm thick melamine coating, to dramatically reduce noise emissions into adjacent rooms.
- Fixing brackets, made of galvanized steel sheet, integrated in the casings to speed up installation.
- Circular spigots for connection to standard commercial hoses, fitted with a double lip rubber gasket for perfect air tightness.
- Highly efficient backward curved centrifugal impellers directly coupled with energy saving, speed controllable (0-10 V signal) single-phase, EC (brushless), protected against overheating, external rotor motors. Ball bearings to grant long lasting (at least 40.000 h) continuous duty at the maximum rated temperature. Speed setting through Vortice potentiometers (optional).
- Electrical connection boxes, made of plastic resin shock proof and resistant to aggressive agents, with a very high (IP55) protection against dust and water.
- Protection against dust and water: IP44 (when ducted)
- Electric insulation class: I (grounding mandatory).

### TECHNICAL DATA

Models	Code	V 50/60Hz	W*	A	Max airflow*		Max pressure*		Max* °C	Kg
					m <sup>3</sup> /h max	l/s max	mmH <sub>2</sub> O max	Pa max		
CA-IL 100 QUIET ES	16270	220/240	85	0,73	310	86,1	71,4	700	40	5,6
CA-IL 125 QUIET ES	16271	220/240	85	0,74	380	105,5	72,4	710	40	5,6
CA-IL 150 QUIET ES	16274	220/240	85	0,73	450	125	63,2	620	40	6
CA-IL 160 QUIET ES	16275	220/240	85	0,74	480	133,3	61,1	600	40	6
CA-IL 200 QUIET ES	16276	220/240	110	0,91	850	236,1	56	550	40	6,2

\* Values referred to 230V/50Hz



## ENERGY DATA FOR REGULATION N° 1254/2014/UE

	UNIT OF MEASURE	CA-IL 100 QUIET ES	CA-IL 125 QUIET ES	CA-IL 150 QUIET ES	CA-IL 160 QUIET ES	CA-IL 200 QUIET ES
CODE		16270	16271	16274	16275	16276
Supplier's name or trade mark	-	Vortice	Vortice	Vortice	Vortice	Vortice
SFPint	W(m³/s)	1002,42	770,82	644,12	585,45	413,18
Declared typology	-	NRVU-U**	NRVU-U**	NRVU-U**	NR-VU-U**	NR-VU-U**
Type of drive	-	MSD***	MSD***	MSD***	MSD***	MSD***
Type of heat recovery system HRS	-	None	None	None	None	None
Nominal NRVU flow rate	m³/s	0,0794	0,0883	0,1150	0,1197	0,2208
Effective electric power input	kW	0,085	0,085	0,085	0,085	0,109
Face velocity at design flow rate	m/s	10,115	7,1980	6,5076	5,9545	413,18
Nominal external pressure ( $\Delta p_s, ext$ )	Pa	26	78	41	52	36
Internal pressure drop of ventilation components ( $\Delta p_s, int$ )	Pa	386	314	278	262	185
Internal pressure drop of non-ventilation components ( $\Delta p_s, add$ )	Pa	0	0	0	0	
Static efficiency of fans used in accordance with Regulation (EU) N. 327/2011	%	38,5	40,7	43,2	44,8	44,8
Declared maximum internal leakage rate of the casing of ventilation units	%	NA*	NA*	NA*	NA*	NA*
Declared maximum external leakage rate of the casing of ventilation units	%	NA*	NA*	NA*	NA*	NA*
Energy performance or classification of the filters	-	NA*	NA*	NA*	NA*	NA*
Description of visual filter warning	-	NA*	NA*	NA*	NA*	NA*
Casing sound power level	LWA[dB(A)]	59	59	56	56	58

\*NA: Not applicable - \*\*RVU-U: Non Residential Ventilation Unit - Unidirectional - \*\*\*MSD: Multi-Speed Drive

## SOUNDS LEVELS

Models	Breakout sound power LwA dB(A)			Sound pressure Lp <sub>3m</sub> * dB(A)			Sound power on extract dB(A)			Sound power on supply dB(A)		
	Max Speed	Mid Speed	Min Speed	Max Speed	Mid Speed	Min Speed	Max Speed	Mid Speed	Min Speed	Max Speed	Mid Speed	Min Speed
CA-IL 100 QUIET ES	60	47	36	39,5	26,5	15,5	61	52	42	72	63	53
CA-IL 125 QUIET ES	59	47	37	38,5	26,5	16,5	62	51	41	71	61	52
CA-IL-150 QUIET ES	56	47	41	35,5	26,5	20,5	60	53	47	71	64	57
CA-IL 160 QUIET ES	56	47	41	35,5	26,5	20,5	58	48	40	68	60	51
CA-IL 200 QUIET ES	58	53	43	37,5	32,5	22,5	63	55	46	74	67	56

\*Calculated in free field conditions at 3 m distance in accordance with EN ISO 374 standard.

**CA IN-LINE QUIET ES RANGE**  
SOUNDPROOF COMPACT FLAT IN-LINE CENTRIFUGAL EC FANS

**DIMENSIONS**

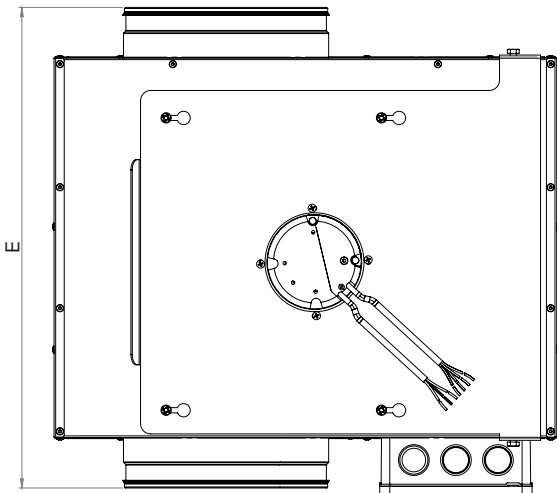
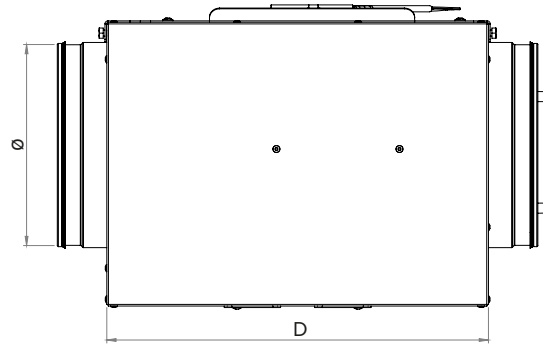
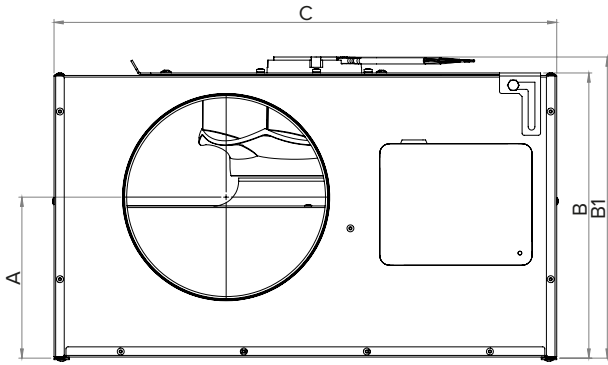

Models	A	B	B1	C	D	E	Ø
CA-IL 100 QUIET ES	134	203	203	427	307	411,5	100
CA-IL 125 QUIET ES	120,5	203	203	427	307	411,5	125
CA-IL 150 QUIET ES	143	238	203	442	307	412	150
CA-IL 160 QUIET ES	138	238	203	490	362	467	160
CA-IL 200 QUIET ES	163	277	288,5	490	372	468,5	200

Dimensions (mm)

**PERFORMANCE CURVES**

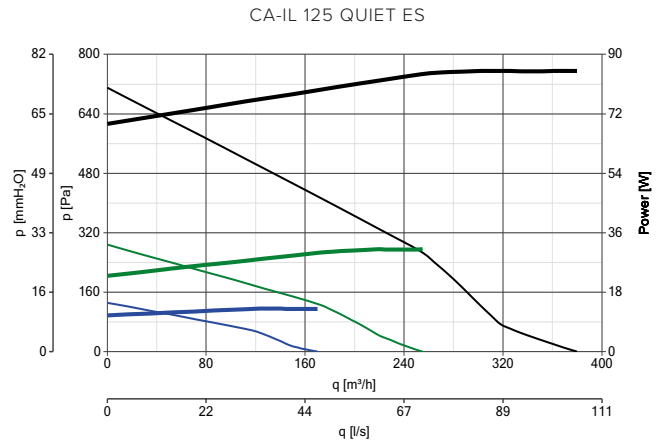
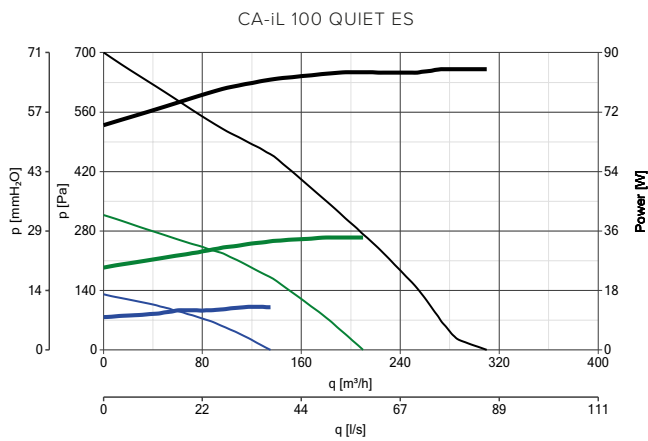

POWER CONSUMPTION  
 — max  
 — med  
 — min

PERFORMANCE CURVES  
 — max  
 — med  
 — min



### PERFORMANCE CURVES

CA-IL 150 QUIET ES

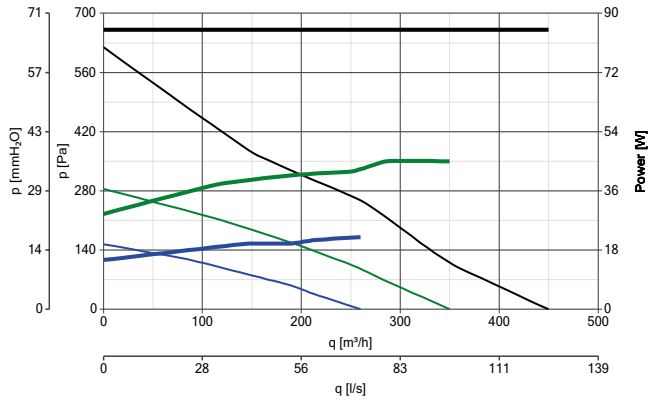

CA-IL 160 QUIET ES

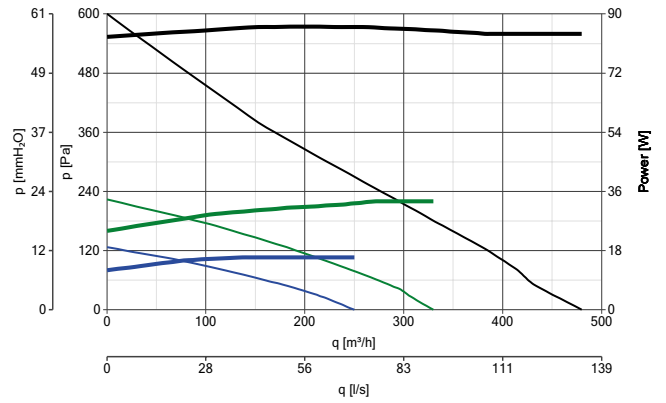

CA-IL 200 QUIET ES

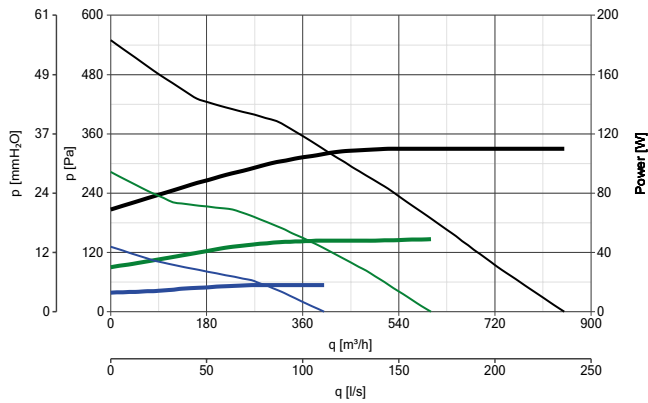







POWER CONSUMPTION      PERFORMANCE CURVES

— max                      — max  
— med                      — med  
— min                      — min

**CA IN-LINE QUIET ES RANGE**  
SOUNDPROOF COMPACT FLAT IN-LINE CENTRIFUGAL EC FANS

**CONTROLLERS**

MODELS	DESCRIPTION	CODE	PRODUCT
	<b>C 1.5</b> - ELECTRONIC SPEED CONTROLLER 1.5 A	12966	ALL PRODUCTS
	<b>KIT SCB</b> - BUILT-IN CONTROLLER ADAPTOR	22481	12966
	<b>POT-IT</b> - POTENTIOMETER	12826	ALL PRODUCTS
	<b>POT</b> - POTENTIOMETER	12828	ALL PRODUCTS
	<b>TRIO</b> - 3 SPEED SWITCH FOR WALL AND FLUSH MOUNTING INSIDE UNI 503 STANDARD ELECTRIC BOXES	21196	ALL PRODUCTS
	<b>TRIO D</b> - 3 SPEED SWITCH FOR WALL AND FLUSH MOUNTING INSIDE DIN STANDARD ELECTRIC BOXES	12866	ALL PRODUCTS
	<b>IREM D</b> - ELECTRONIC STEPLESS SPEED SWITCH FOR WALL AND FLUSH MOUNTING INSIDE DIN STANDARD ELECTRIC BOX	12867	ALL PRODUCTS

**ACCESSORIES ON REQUEST**

MODELS	DESCRIPTION	CODE	PRODUCT
		100	21177
		125	21178
	<b>GR</b> - PROTECTIVE METAL GRIDS (TO BE ASSEMBLED ON THE PRODUCT)	150	21179
		160	21180
		200	21181
		100	21182
		125	21183
	<b>FS</b> - FLEXIBLE SLEEVES WITH CLAMPS FOR HOSE FASTENING	150	21184
		160	21185
		200	21186
	<b>TRA 250</b> - OUTLET PORT PROTECTION GRILLES - FITTED TO THE APPLIANCE INTAKE TO PREVENT ACCIDENTAL CONTACT WITH MOVING PARTS IF THE APPLIANCE IS INSTALLED IN AN ACCESSIBLE POSITION	51150	16275 - 16276
	<b>PGR 250</b> - PLASTIC MADE GRAVITY SHUTTERS	50150	16275 - 16276









## VORTICE GROUP COMPANIES

### VORTICE S.P.A

Strada Cerca, 2  
Frazione di Zoate  
20067 Tribiano  
(Milan) Italy  
Tel. (+39) 02 906991  
Fax (+39) 02 90699625  
vortice.com

### VORTICE LIMITED

Beeches House  
Eastern Avenue  
Burton upon Trent  
DE13 0BB United Kingdom  
Tel. (+44) 1283 492949  
Fax (+44) 1283 544121  
vortice.ltd.uk

### VORTICE INDUSTRIAL S.R.L.

Via B. Brugnoli 3,  
37063 Isola della Scala  
(Verona) Italy  
Tel. (+39) 045 6631042  
Fax (+39) 045 6631039  
vorticeindustrial.com

### CASALS VENTILACIÓN AIR INDUSTRIAL S.L.

Ctra. Camprodon, s/n 17860  
Sant Joan de les Abadesses  
(Girona) Spain  
Tel. (+34) 972720150  
casals.com

### VORTICE LATAM S.A.

Bodega #6  
Zona Franca Este Alajuela,  
Alajuela 20101  
Costa Rica  
Tel. (+506) 2201.6934  
vortice-latam.com

### VORTICE VENTILATION SYSTEM

(Changzhou) Co.LTD  
No. 388 West Huanghe Road  
Building 19, Changzhou  
Post Code: 213000 China  
Tel. (+86) 0519 88990150  
Fax (+86) 0519 88990151  
vortice-china.com

### TOLL-FREE NUMBER

**800 555 777**

The descriptions and illustrations in this catalogue are intended to be indicative and not binding. Without prejudice to the essential characteristics of the products described and illustrated here, VORTICE reserves the right to make, at any time and without notice, any changes to parts, aesthetic details or supply of accessories to its products that are deemed to be appropriate for improvement or for any construction or commercial requirement.  
This printout completely cancels and replaces all previous ones.

